

16" Planer with ShearTec II Manual



LAGUNA

LAGUNA TOOLS
2072 Alton Parkway
Irvine, California 92606
Ph: 800.234.1976
www.lagunatools.com

Model Numbers: MPLAN1510-0120

© 2018, Laguna Tools, Inc. LAGUNA® and the LAGUNA Logo® are the registered trademarks of Laguna Tools, Inc. All rights reserved.

Table of contents

	Page number
Safety Rules	4
Warranty	5
Noise emission	6
Specification sheet	6
Receiving your planer	7
Introduction to your planer	7
What you will receive with the planer	8
Parts of the planer	9
Where to locate your planer	10
Unpacking your planer	10
Assembly and setup	11
Running and adjusting the planer	14
Maintenance	19
Troubleshooting	21
Exploded view drawings	

Safety Rules

As with all machinery, there are certain hazards involved with the operation and use. Using it with caution will considerably lessen the possibility of personal injury. However, if normal safety precautions are overlooked or ignored, personal injury to the operator may result. If you have any questions relative to the installation and operation, do not use the equipment until you have contacted your supplying distributor.

Read carefully before operating the machine.

- 1. Keep the working area clean and be sure adequate lighting is available.**
- 2. Do not wear loose clothing, gloves, bracelets, necklaces or ornaments. Wear face, eye, respiratory and body protection devices as indicated for the operation or environment.**
- 3. Be sure that the power is disconnected from the machine before tools are serviced or an attachment is to be fitted or removed.**
- 4. Never leave the machine with the power on.**
- 5. Do not use dull, gummy or cracked cutting tools.**
- 6. Be sure that the keys and adjusting wrenches have been removed and all the nuts and bolts are secured.**

Limited Warranty

New machines and accessories sold by Laguna Tools carry a one-year warranty effective from the date of shipping. Machines sold through dealers must be registered with Laguna Tools within 30 days of purchase to be covered by this warranty. Laguna Tools guarantees all new machines and accessories sold to be free of manufacturers' defective workmanship, parts and materials. We will repair or replace, without charge, any parts determined by Laguna Tools, Inc. to be a manufacturer's defect. We require that the defective item/part be returned to Laguna Tools with the complaint. Any machines returned to Laguna Tools must be returned with packaging in the same manner in which it was received. If a part or blade is being returned it must have adequate packaging to ensure no damage is received during shipping. In the event the item/part is determined to be damaged due to lack of maintenance, cleaning or misuse/abuse, the customer will be responsible for the cost to replace the item/part, plus all related shipping charges. This limited warranty does not apply to natural disasters, acts of terrorism, normal wear and tear, product failure due to lack of maintenance or cleaning, damage caused by accident, neglect, lack of or inadequate dust collection, misuse/abuse or damage caused where repair or alterations have been made or attempted by others.

Laguna Tools, Inc. is not responsible for additional tools or modifications sold or performed (other than from/by Laguna Tools, Inc.) on any Laguna Tools, Inc. machine. Warranty maybe voided upon the addition of such described tools and/or modifications, determined on a case-by-case basis.

Software purchased through Laguna Tools Inc. is not covered under this warranty and all technical support must be managed through the software provider. Software is non-refundable.

Normal user alignment, adjustment, tuning and machine settings are not covered by this warranty. It is the responsibility of the user to understand basic machinery operation, settings and procedures and to properly maintain the equipment in accordance with the standards provided by the manufacturer.

Parts, under warranty, are shipped at Laguna Tools, Inc.'s cost either by common carrier, FEDEX ground service or a similar method. Technical support to install replacement parts is primarily provided by phone, fax, e-mail or Laguna Tools Customer Support Website. The labor required to install replacement parts is the responsibility of the user.

Laguna Tools is not responsible for damage or loss caused by a freight company or other circumstances not in our control. All claims for loss or damaged goods must be notified to Laguna Tools within twenty-four hours of delivery. Please contact our Customer Service Department for more information.

Only **new** machines sold to the original owner are covered by this warranty. For warranty repair information, **call 1-800-332-4094**.



Noise emission.

Notes concerning noise emission

Given that there exists a relationship between noise level and exposure times, it is not precise enough to determine the need for supplementary precautions. The factors affecting the true level of exposure to operators are clearly the amount of time exposed, the characteristics of working environment, other sources of dust and noise, etc. For example, adjacent machines, in other words, affect the level of ambient noise. It is possible that exposure level limits will vary from country to country.

Specification sheet.

Machine	Platinum Series 16" Planer MPLAN1510- 0130
Motor	5hp
Planer table size	25" x 20"
Cutter head	Shear-Tec 6 Row Spiral
Dust chute diameter	4 inches
Cut Capacity:	16" x 8" (W x H)
Maximum planing depth	1/8 inch
Feed speeds	16 TO 20 feet per min
Cutter speed	3420 rpm
Volts	220 V single phase
Weight net	560 lbs

Receiving your machine.

Note. It is probable that your machine will be delivered by a third party. Before you unpack your new machine, you will need to first inspect the packing, invoice and shipping documents supplied by the driver.

Ensure that there is no visible damage to the packing or the machine. You need to do this prior to the driver leaving. All damage must be noted on the delivery documents and signed by you and the delivery driver. You must then contact the seller (Laguna Tools) within 24 hours.

Introduction to planers

The planer is designed to give you years of safe service. Read this owner's manual in its entirety before assembly or use.

The planer is generally defined as a machine that cuts planks of wood smooth and parallel. There are many types of cutter head, and this machine uses an inserted cutter type. The insert cutters main advantage is to reduce tear out of the grain, but the finish is not as smooth as the parallel blade system. It is well within the capabilities of a belt sander to give a professional finish to the jointed plank.



The parallel blade system, gives a finish without the lines that the insert cutter system gives, but, is susceptible to tear out, especially on planks with knots. On balance, it is better to use a machine with the insert cutters than the parallel blades, as it greatly reduces the risks of having to scrap valuable wood, or spending excessive time sanding tear out marks.

Additional Instructions for the use of planers

Like all machines, there is danger associated with the machine. Injury is frequently caused by lack of knowledge or familiarity. Use this machine with respect. If normal safety precautions are overlooked or ignored, serious personal injury may occur.

1. Supporting the work.

Only make cuts if the work piece is stable and never attempt to cut unstable planks, or injury may occur.

2. Cutting depth.

Never exceed the maximum cutting depth as stated in the specification for your machine. It is far better to take several small cuts, rather than large cuts.

3. Direction of cut.

Planing against the grain is dangerous and could produce chatter or excessive chip out. Always plane with the grain.

4. Guards.

Guards are designed to reduce the risk of injury. **Always use the guards.**

5. Stock.

Your safety will be greatly enhanced if you only use good lumber. Only work with lumber after you have inspected it completely. Staples, nails, loose knots and any other metal in the plank will damage your cutter head and could cause injury or fire. If you have any question about a piece of lumber, do not use it.

What you will receive with the planer.

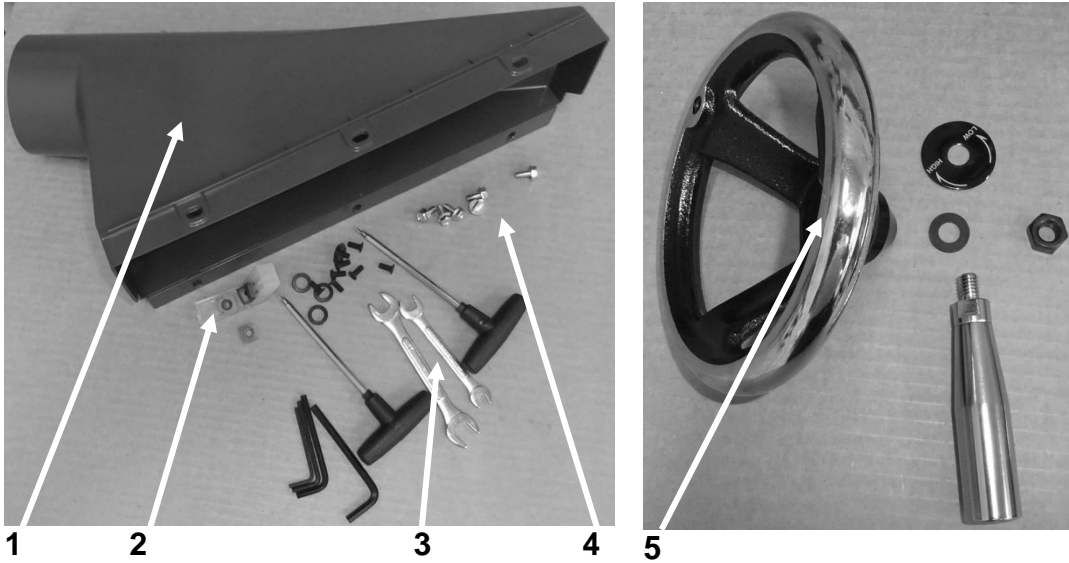

1. Dust shute.
2. Spare cutter teeth
3. Tools
4. Screws.
5. Handle.
6. Extension tables.

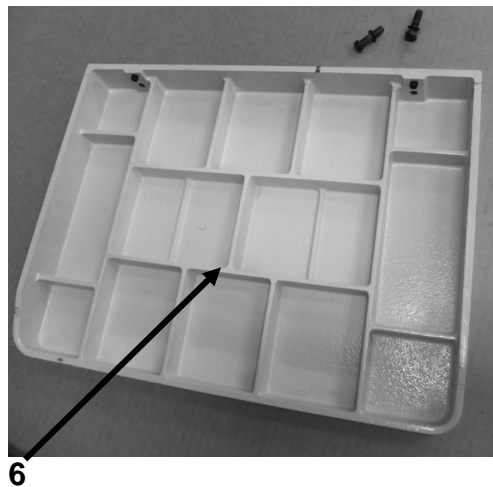

Parts of the planer/moulder.

The planer/moulder major parts are discussed in this manual. If you are not familiar with the planer/moulder, take the time to read this section and become familiar with the machine.

1. Body.

The body is made from pressed steel and is designed to give the machine support and rigidity.

2. Lifting rods.

The lifting rods are extendable from the machine. Lifting straps can be attached to the rods when lifting or moving the machine.

3. Support rollers.

The support rollers, support the work piece when returning back for additional cuts.

4. Start/stop switch.

5. Power cable.

No power cable is supplied with the machine. A power cable will have to be connected to the termination box at the back of the machine.

6. Table.

The table is made from cast iron and supports the work while it is being machined. The table has a fine ground finish.

7. Dust chute.

A 4-inch diameter dust chute is provided. The dust chute must be connected to a dust collector with a minimum capacity of 1000 c.f.m. The machine produces a lot of sawdust and wood chippings; the stronger the dust collector the better.

8. Table adjusting handle.

The table adjusting handle raises and lowers the table.

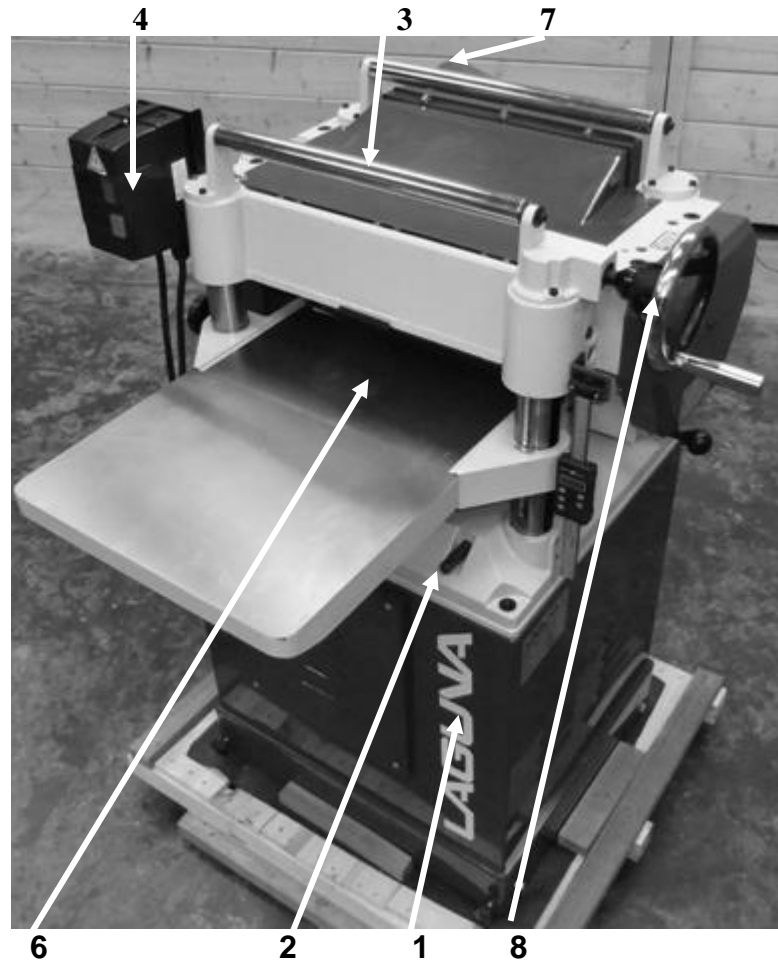

Where to locate your machine.

Before you remove your machine from the pallet, select the area where you will use your machine. There are no hard-and-fast rules for its location, but below are a few guidelines.

1. There should be an area at the front and back of the machine suitable for the length of wood that you will be machining.
2. Adequate lighting. The better the lighting, the more accurate and safely you will be able to work.
3. Solid floor. You should select a solid, flat floor, preferably concrete or something similar.
4. Close to power source and dust collection.

Unpacking your machine.

To unpack your machine, you will need tin snips, knife and a wrench.

1. Using the tin snips, cut the banding that is securing the machine to the pallet (if fitted).

WARNING: EXTREME CAUTION MUST BE USED BECAUSE THE BANDING WILL SPRING AND COULD CAUSE INJURY.

2. Lift the box off and discard.
3. Using the knife, cut the plastic wrap from the top. The accessories that were ordered could be attached to the side of the machine, and extreme caution must be taken so that the parts do not fall and cause injury or damage. Remove them and set aside.
4. Some of the parts supplied with the machine may be shipped inside the machine. To access these parts, remove the machine side panels.
5. Remove the base mounting bolts that secure the machine to the pallet. The mounting bolts are accessed from underside of the pallet [If fitted].

6. The machine can be lifted using a forklift truck or hoist.

To lift the machine off the pallet using a sling, pull the lifting rods out from the machine's main body. Fit the sling around the sling rods and lift the machine off the pallet with a hoist. The hoist must have a lifting capacity of no less than 2000 lbs. Remove the pallet and lower the machine to the floor.

Note. The machine is heavy, and if you have any doubt about the described procedure, seek

professional assistance. Do not attempt any procedure that you feel is unsafe or that you do not have the physical capability of achieving.



Lifting rods

Assembly and setup.

Mobility kit.

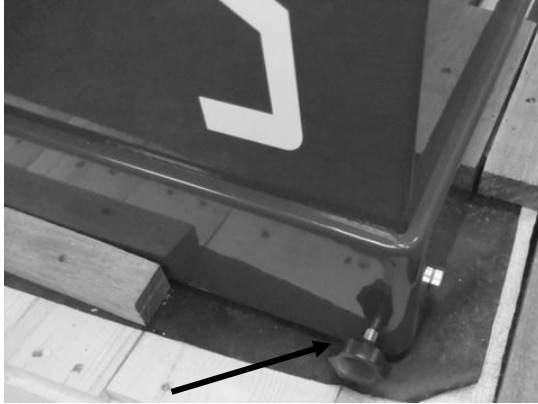

Mobility clamp screw

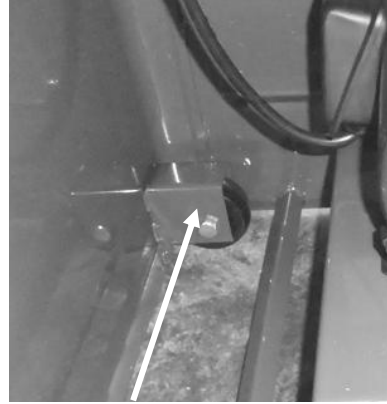

Mobility wheel

The mobility wheels come pre-fitted to the base of the machine.
The wheels are locked by tightening the clamp screws on the outside of the body.

Fitting the dust chute.

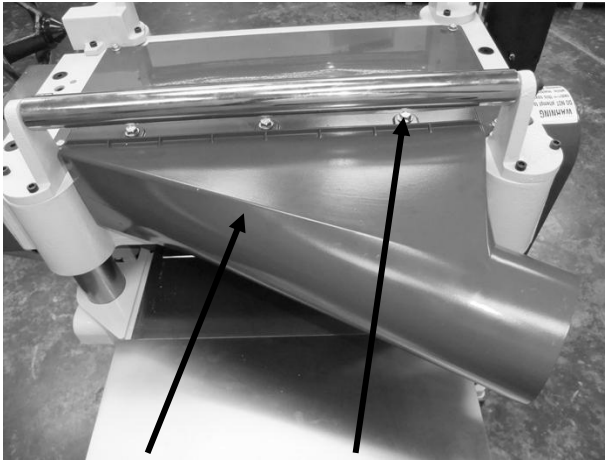

Dust chute Upper fixing screws



Lower fixing screws

Note. The dust chute has to be removed to access the cutter head.
Attach the dust chute with the upper and lower fixing screws.

Connecting the electrical supply.

Note. A qualified electrician must carry out the installation.

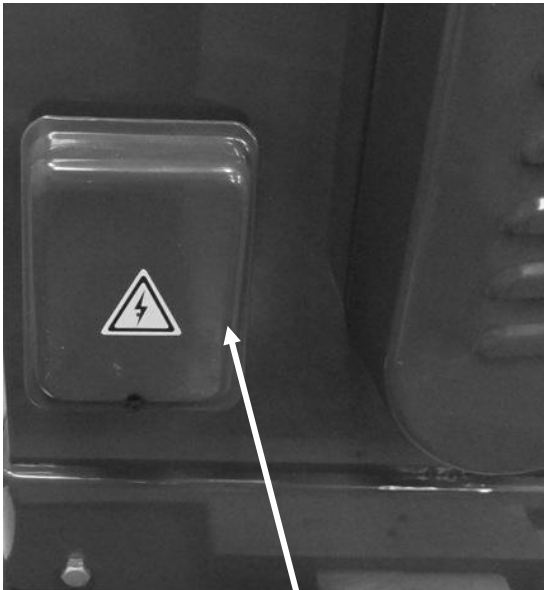

Power termination box



Cover removed

Ensure that the electrical supply corresponds with that of the machine (single-phase 220 V).

It is recommended that you use a 30-amp mains breaker.

The mains cable must be connected into the power termination box.

Note. The machine is not normally supplied with an electrical cable or plug, as the type of plug and the length of the cable will be dependent on the installation.

Connecting the dust collection.

Connect a 4-inch flexible hose between the dust collection hood and your dust collector. Once fitted, pull on the hose to ensure that the connection is tight. You do not want it to come off during production.

Note. You will need a dust collection system with a minimum of 1000-cubic-foot-per-minute capacity. The stronger the dust collection the better, as the machine is capable of producing a lot of waste.

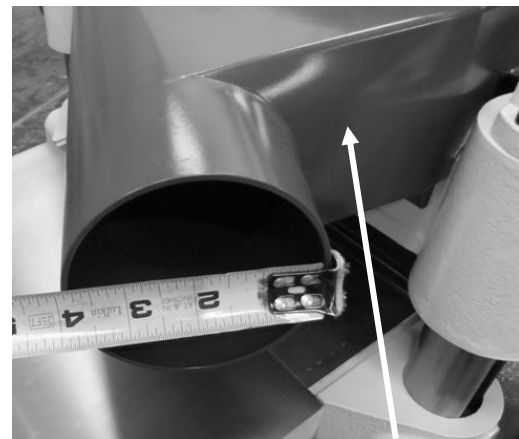

Dust collection hood

Fitting the vertical adjustment handle.

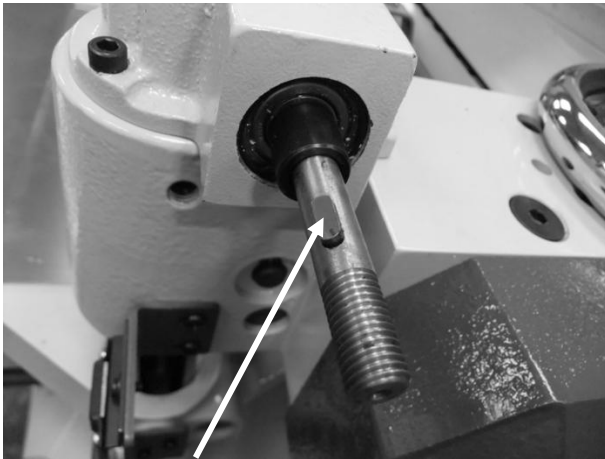

Key



Handle

1. Clean the shaft and the key.
2. Slide the handle onto the shaft. Ensure that the key lines up with the key way in the handle, and that the key is bottomed out in the shaft slot. You may have to gently tap the handle, as the key may be a tight fit.
3. Fit the washer and nut as shown.

Fitting the extension tables.

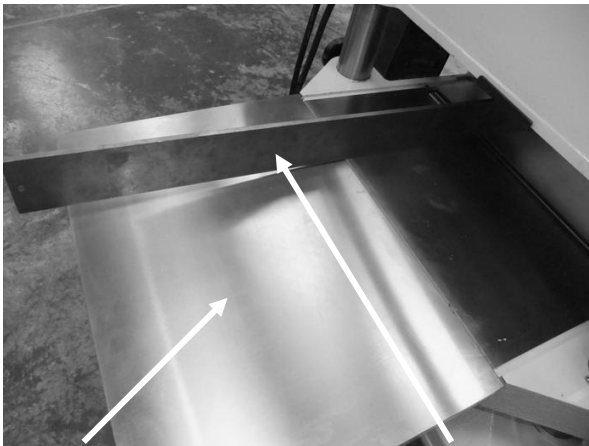

Extension table

Straight edge

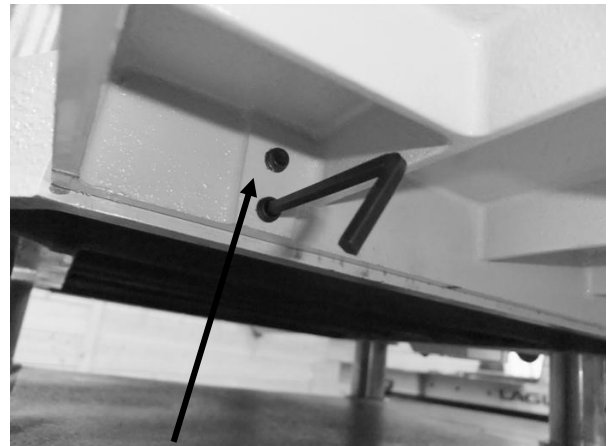

Fixing and jacking screws

There are two extension tables, one on either side of the machine. The tables are attached to the main table with fixing screws, and jacked level with the main table by allen set screws.

1. Attach the extension tables to the main table with the fixing bolts.
2. Place a straight edge on both the main table, and one of the extension tables.

3. Bring the extension table up level with the main table [check both sides of the table].

4. By loosening one of the fixing bolts and tightening the jacking screw, the table can be jacked parallel with the main table. This process must be done slowly jacking a small amount each side so that no excessive strain is put on the table flange. Excessive jacking could crack the cast iron table.

5. Once the tables are parallel, check that both tables are still level and adjust if required.

6. Repeat for the other extension table.

Note. The tables must be checked at both sides.



Straight edge

Cleaning the machine.

The machine is shipped with the non-painted surfaces protected from rust by a film of grease.

The grease must be removed with WD40 or similar, as it attracts saw dust and dirt. The surfaces should then be coated with a Teflon lubricant or similar. Teflon tends to dry and will not attract sawdust and dirt. To reduce table friction, it is recommended that the table is polished with a good-quality wax. This will also afford a degree of protection from rust.

Anti-kickback teeth.

The anti-kickback teeth must be free to move, or they will not fulfill their function.

With the power disconnected, check that all the teeth move freely. If they do not, lubricate with Teflon-based lubricant.



Anti-kickback teeth

Running and adjusting the machine.

Adjustments.

Note. The machine has had all its functions calibrated at the factory, but due to shipping conditions, some movement may have taken place. This is unavoidable, and it is therefore recommended that the following checks are made prior to starting

production. As the machine is used, some functions may move, and it is good practice to know the process for adjusting the machine prior to production.

Test Run

Now that the assembly is complete it is time to conduct a test run.

During the test run you will check the following points.

1. Motor starts and runs smoothly.
2. That the stop buttons function correctly.

Before you run the machine check the following.

1. All the tools have been removed from the machine.
2. All the guards are in place.
3. You are wearing the appropriate safety equipment.
4. You have read and understood the instruction manual.

Note. If any of the below functions fail to operate correctly, the fault must be corrected prior to continuing to the next test. Any investigation to find or correct a fault must be conducted with the power disconnected.

1. Start the machine by pressing the green start button.

The machine should run smoothly with little or no vibration.

2. Press the red stop button. The machine should slow down and stop.

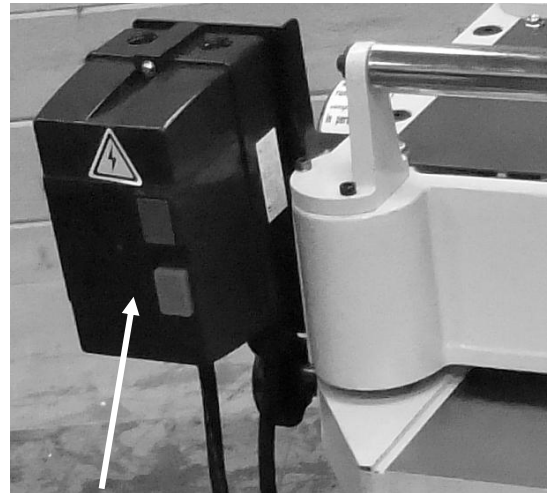

Stop and start buttons

Power feed.

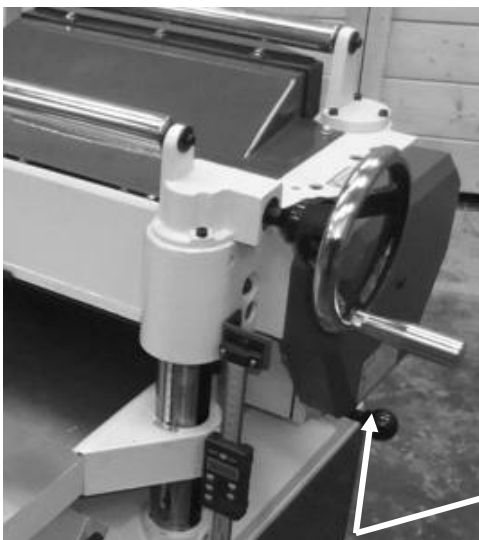

Power feed handle

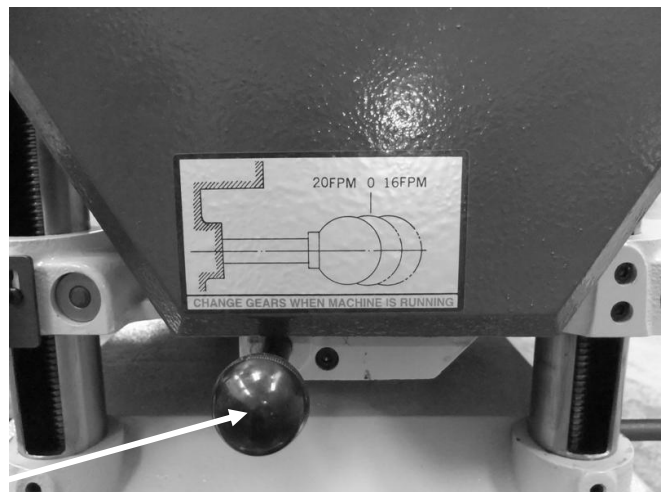

To engage the power feed rollers, pull or push the power feed handle with the motor running. Pushing the handle in, selects 20 FPM and pulling it out selects 16 FPM. The centre position is neutral.

Note. Only engage and disengage the power feed with the motor running.

Adjusting the table height.



Table height adjusting handle



Height scale

Scale fixing screw

Height digital read out

To adjust the height of the table, rotate the height adjusting handle. Once at the required height, clamp the table in position with the table clamp handle.

The height scale comes factory set, and should not need adjustment. If movement has taken place during shipping, adjust as follows.

1. Plane a plank of wood to a convenient thickness.
2. Check the thickness of the plank.
3. Check the reading on the scale.
4. If adjustment is required, loosen the fixing screws, readjust the position of the scale, and tighten the screws.

Set the digital read out as follows.

1. Skim the job in hand.
2. Measure the thickness of the job.
3. Press and hold for a few seconds the set button. The display will go to zero.
4. Adjust the table for the amount that you require to be removed.

Note. Always clamp the table in position with the clamp handles after table adjustment.

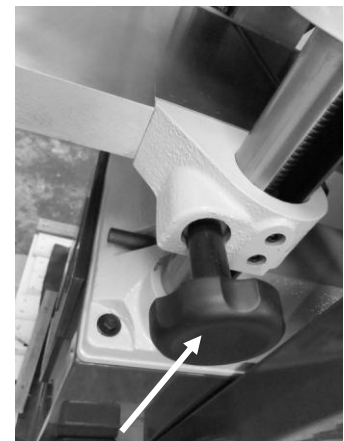
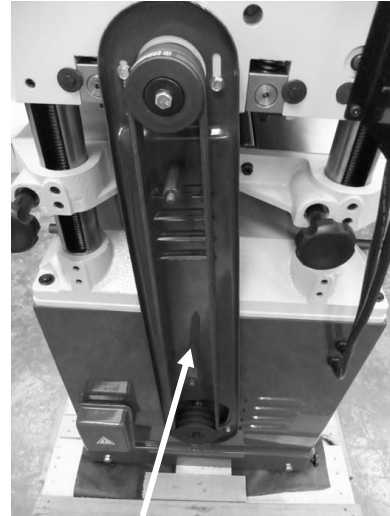

Table clamp handle

Adjusting the drive belts.



Motor adjuster



Cover removed

The drive belts should be checked after running the machine for approximately 10 hours. The belts bed into the pulleys and will slacken off slightly. If they are not adjusted, slippage may accrue, and this will cause early belt failure. There should be approximately 3/16" deflection when the belt is pressed with moderate finger pressure.

To increase the tension on the belts, loosen the motor adjuster lower nut. Tighten the upper nut to increase the belt pressure.

Note. To access the drive belts, and motor, remove the side cover, and belt cover.

Note. Disconnect the power to the machine prior to conducting machine adjustments or repairs.

Fitting teeth to the Sher tec cutter head

The carbide cutter head [Sher Tec] has multiple teeth, which have 4 cutting edges. When they are blunt, or damaged, the teeth can be rotated as follows,

Note. You will notice that each cutter tooth has a registration dot, to enable you to ensure that the teeth are moved round in the same direction.

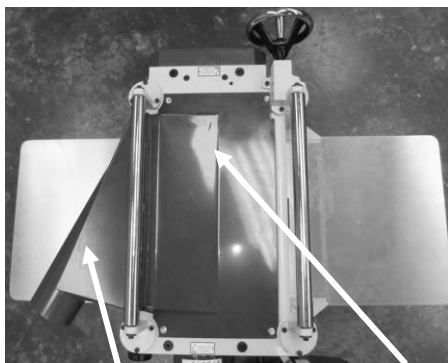

Dust shute

Cover



Registration dot

1. With the power disconnected from the machine. Remove the cutter head cover, and the dust shute.

2 Loosen the tooth with the special allen key.

2. Lift the tooth and rotate to the new cutting face.

Note. Take special care to clean the tooth and its mating surface. Any dirt or sawdust that is trapped under the tooth will cause it to be at a different height to the other teeth and degrade the surface finish when you start machining. This will result in you having to take all

the teeth out, and clean the teeth, and the mating surfaces again. This is very frustrating and a waste of time, take your time and ensure that you are very thorough with cleaning.

3. Lower the tooth into the cutter head and clamp with the allen key.

Note. Only move all the teeth to a new cutting edge. Do not move less than all the teeth.

Note. The carbide cutter head has several advantages over the parallel blade type cutter head.

1. The teeth are carbide and will last longer than high speed steel parallel blades.

2. There is less chance of tare out.

The disadvantage is that they are initially more expensive and that the surface finish is slightly wavy. This is caused because the teeth have a very slight radius. This waviness is easily removed by a light sanding.

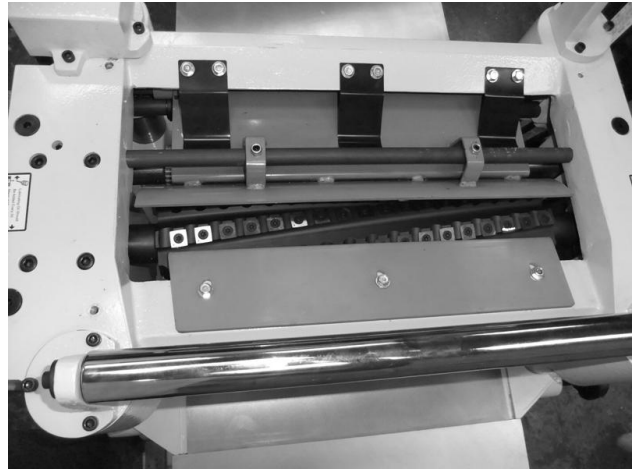

Cover removed

Maintenance.

As with any machine, to ensure optimal performance, you must conduct regular maintenance.

Daily checks.

1. Clean the machine and lubricate unpainted surfaces with a Teflon-based lubricant. Wipe off any excess and buff with a dry polishing cloth. This will reduce the likelihood of rust forming and reduce the friction on the tables as the wood is machined.
2. Check cutter blades for chips and dullness.
3. Generally inspect the machine for damage and loose or worn parts.

Weekly checks.

1. Clean the cutter head.
2. Check cutter blades for chips and dullness.
3. Generally inspect the machine for damage and loose or worn parts.
4. Check the dust extraction for blockages and any large bits that could cause blockages.

Monthly checks.

1. Check the motor drive belts for wear, splits and cuts.
2. Clean the motor compartment and the motor to ensure that the motor cooling fins work efficiently.
3. Clean and lubricate the drive chains and cogs.
4. Generally inspect the machine for damage and loose or worn parts.

Note. It is recommended that you use a Teflon-based lubricant.

Drive belt replacement.

Note. Disconnect the power to the machine before conducting any maintenance on the machine.



Motor adjuster



Cover removed

1. Remove the side cover to access the motor.
2. Remove the belt guard to access the drive belts.
3. Loosen the motor adjustor nuts.
4. Remove the drive belts.
5. Fit the new belts.
6. Re-tension the belts by tightening the top motor adjusting nut. There should be a 3/16" deflection when the belt is pressed with moderate finger pressure. Tighten the lock nut.
7. The drive belts should be checked after running the machine for approximately 10 hours. The belts bed into the pulleys and will slacken off slightly. If they are not adjusted, slippage may accrue, and this will cause early belt failure. There should be a 3/16" deflection when the belt is pressed with moderate finger pressure.
8. Refit the side cover and belt guard.

Note. Your machine is fitted with a multi drive belt system. Always replace all the belts with a matched set. **Never** replace only one belt, as this will cause vibration, excessive wear to bearings and result in a poor work finish.

Power drive maintenance

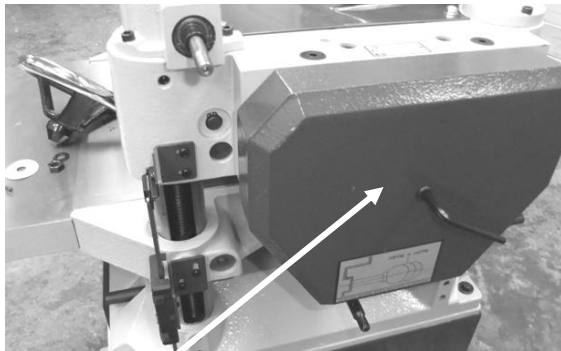

Power drive cover

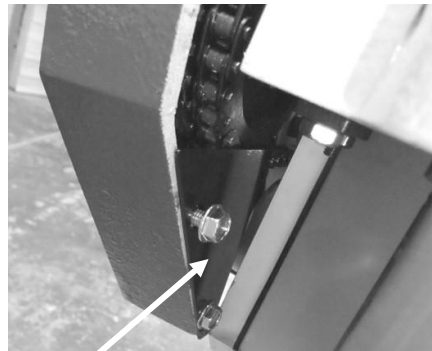

Cover plate

To access the power drive chain, the gear box cover has to be removed, as detailed below.

1. Remove the height adjusting handle.
2. Remove the power drive engage disengage knob.
3. Remove the power drive cover fixing screw.
4. Lift the power drive cover to expose the cover plate, and remove the top fixing screw. Loosen the lower screw and slide the cover plate down.

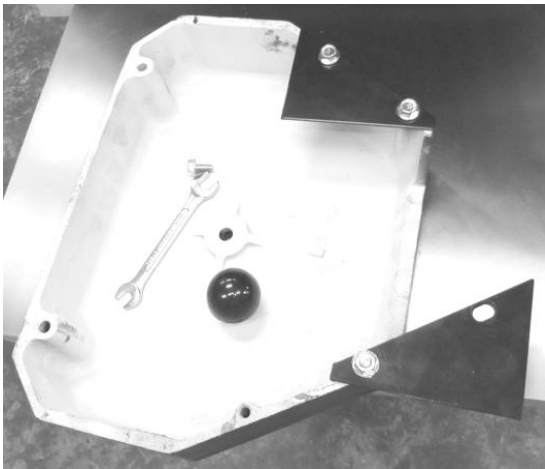

Power drive cover removed

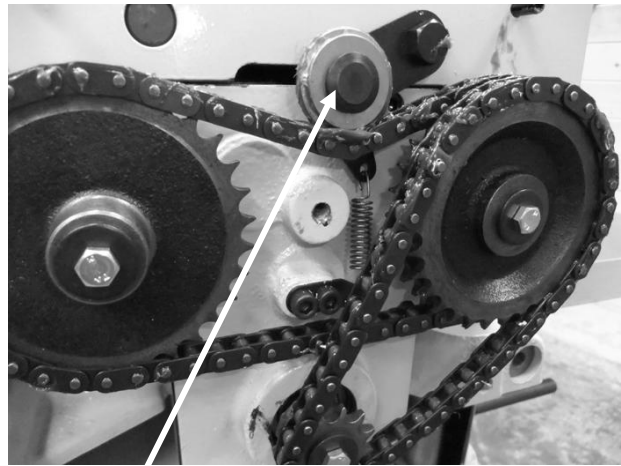

Chain tension wheel

5. Remove the power drive cover.

6. Check that the chain tension wheel is free to move and that the chains are clean and lubricated.

7. Reassemble.

Lubricating the machine.

Lubrication oil to be added every 30 hours of operation, to both sets of holes as shown.

Note. All the bearings are sealed for life and do not require lubrication. If a bearing is noisy, do not try to re-lubricate but replace it.

Note. It is recommended that you use a Teflon-based lubricant, as it tends to dry and therefore will attract less sawdust and dirt. Lubricate the drive chains and cogs.



Lubrication holes

Drive roller and anti-kickback teeth adjustment.

The drive roller pressure roller and anti-kickback teeth must sit below the cutter head teeth.

The drive roller and pressure rollers are sprung loaded and as the wood passes move vertically. This provides the correct amount of pressure to transport the wood past the cutter head and keep the wood firmly in contact with the bed of the machine.

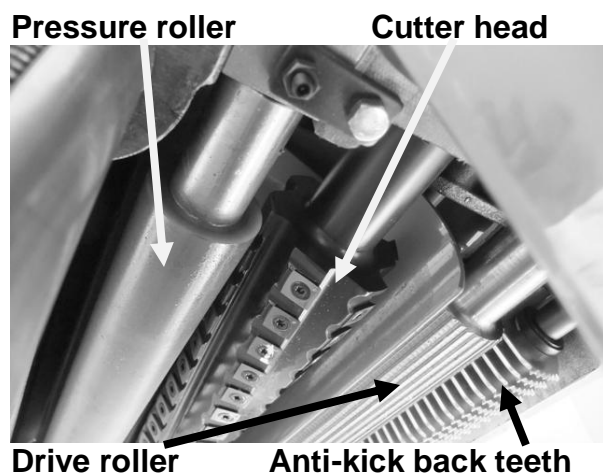

Drive roller

Anti-kick back teeth

The drive roller, pressure roller and anti-kickback teeth come factory set but should adjustment be required proceed as follows.

Loosen the lock nut and move the adjusting screw. Remember to tighten the lock nut once the adjustment has been completed.

Note. There is a screw both sides of the machine for both rollers [four adjusting screws in total]. If parallel adjustment is required both screws must be moved the same amount for each roller.

To adjust for parallel it is suggested that a block of parallel wood is used and placed under the relevant roller at one end. The bed of the machine is then moved vertically so that the wood just touches the relevant roller. Check both sides of the roller that you are adjusting.

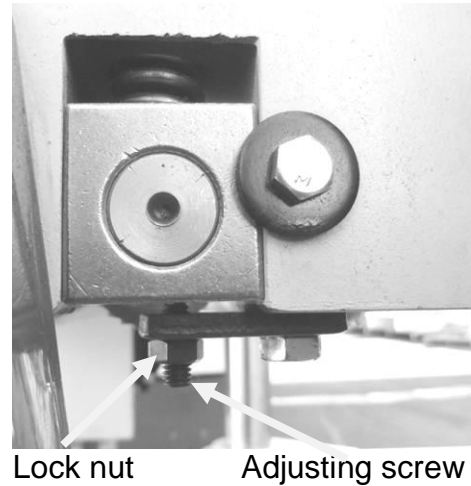

Troubleshooting and fault finding.

Problem	Cause	Corrective action
Motor will not start or fuses or circuit breakers blow.	1. Short circuit	2. Repair or replace short circuit item.
	2. Start capacitor faulty.	3. Fit new capacitor.
	3. Motor thermal protection circuit breaker faulty, or motor is at fault.	4. Replace thermal protection circuit breaker in motor or replace motor.
	4. Open circuit in motor or loose connections.	5. Replace or repair motor or loose connection.
Fuses or circuit breakers blow.	1. Motor drawing excessive current.	1. Repair or replace motor.
	2. Cutter head or motor jammed.	2. Remove jam.
	3. Short circuit.	3. Repair or replace short circuit item.
Motor will not develop full power or motor speed slows with load, over heats or stalls.	1. Motor run capacitor faulty.	1. Replace the capacitor.
	2. Machine overloaded.	2. Take smaller cuts.
	3. Motor overheating.	3. Clean motor, taking care to make sure that all the cooling fins are clean.
	4. Short circuit in motor or loose connections.	4. Repair or replace motor or loose connections.
Cutter head slows or belt squeals when cutting.	1. V-belts loose.	1. Tighten V-belts.
	2. V-belts worn out.	2. Replace V-belts.
Loud noise coming from machine.	1. Motor pulley set screws or keys are missing or loose.	1. Replace or tighten if necessary.
	2. Drive belts are damaged.	2. Replace drive belts.
Tables are hard to adjust.	1. Table spindles are tight.	1. Clean and lubricate spindles.
Job stops or slows during cut.	1. Taking too of a deep cut.	1. Take smaller cuts.
	2. Pitch or build-up on planer components.	2. Clean the tables and cutter head components

Chipping or marks (consistent pattern).	1. Knots or conflicting grain direction in wood.	1. Inspect job for knots and grain direction; only use good material.
	2. Nicked or chipped blades.	2. Replace affected blades.
	3. Taking too of a deep cut.	3. Take smaller cuts.
Furry finish on the grain.	1. Wood has high moisture content or surface wetness.	1. Check moisture content and allow to dry.
	2. Blunt blades.	2. Replace the blades.
Lines or ridges that run along the board.	1. Nicked or chipped blades.	1. Replace blades.
Chatter marks across the face of the board. Uneven blade marks.	1. Worn cutter head bearings.	1. Replace cutter head bearings.
Shiny finish.	1. Blades are blunt.	1. Replace the blades.
	2. Too fine a cut.	2. Increase the depth of cut.
Chip marks, random pattern.	1. Chips not removed from cutter head.	1. Use a dust collection system or a stronger dust collection system
Snipe.	1. Dull blades.	1. Replace blades.
	2. Inadequate support for long board.	2. Use support stand.
Torn grain.	1. Cut too deep.	1. Reduce cut.
	2. Cutting against the grain.	2. Cut with the grain.
	3. Dull blades.	3. Replace the blades.
Poor feeding of job.	1. Feed rollers worn.	4. Replace feed rollers.
	2. Motor belt slippage.	2. Re-tension drive belts.
	3. Table dirty.	3. Clean table.
Tapered cut.	1. Table not parallel to cutter head.	1. Reset table to cutter head.
	2. Blades not adjusted correctly.	2. Reset blades.

Exploded view drawings

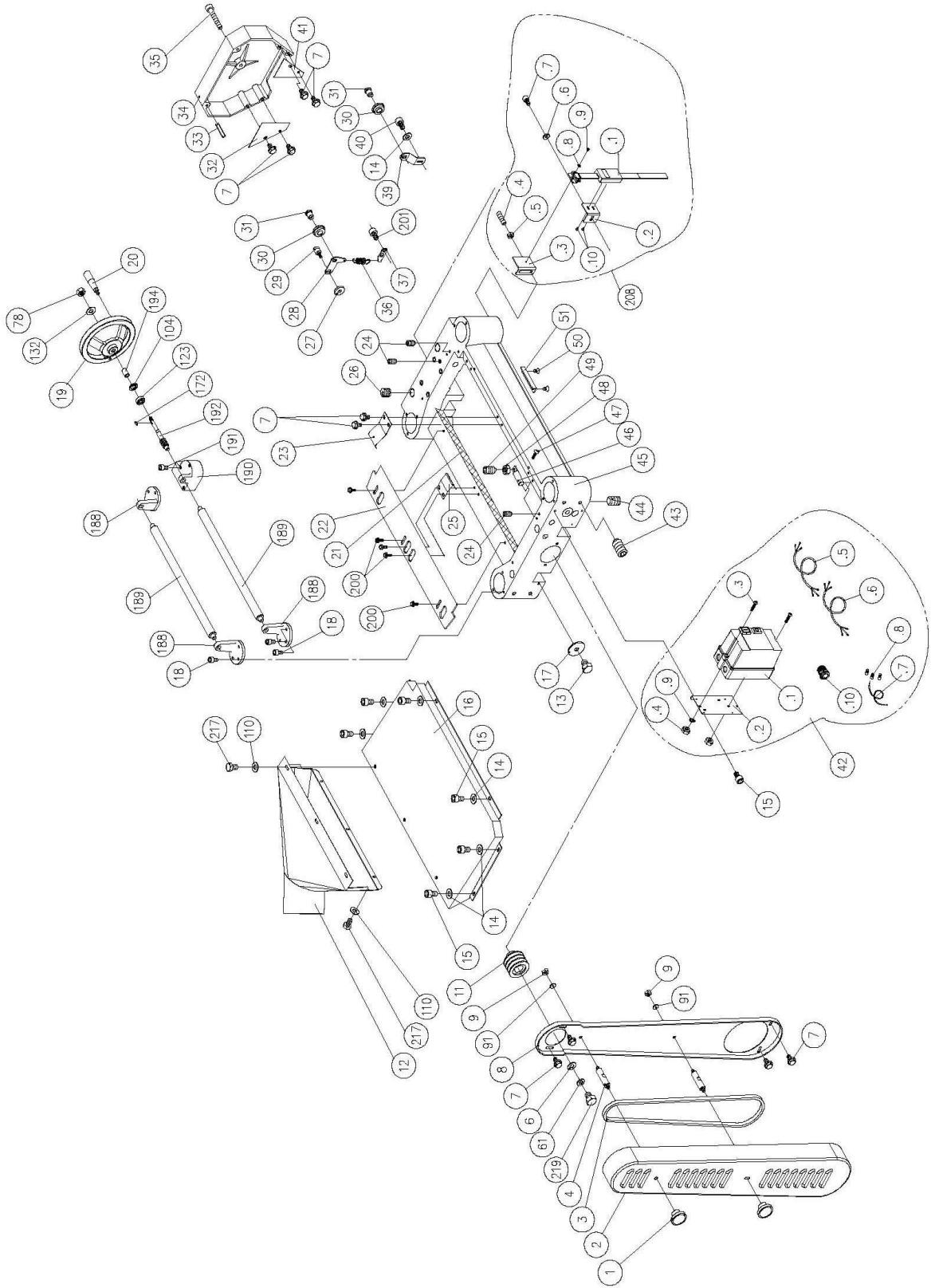

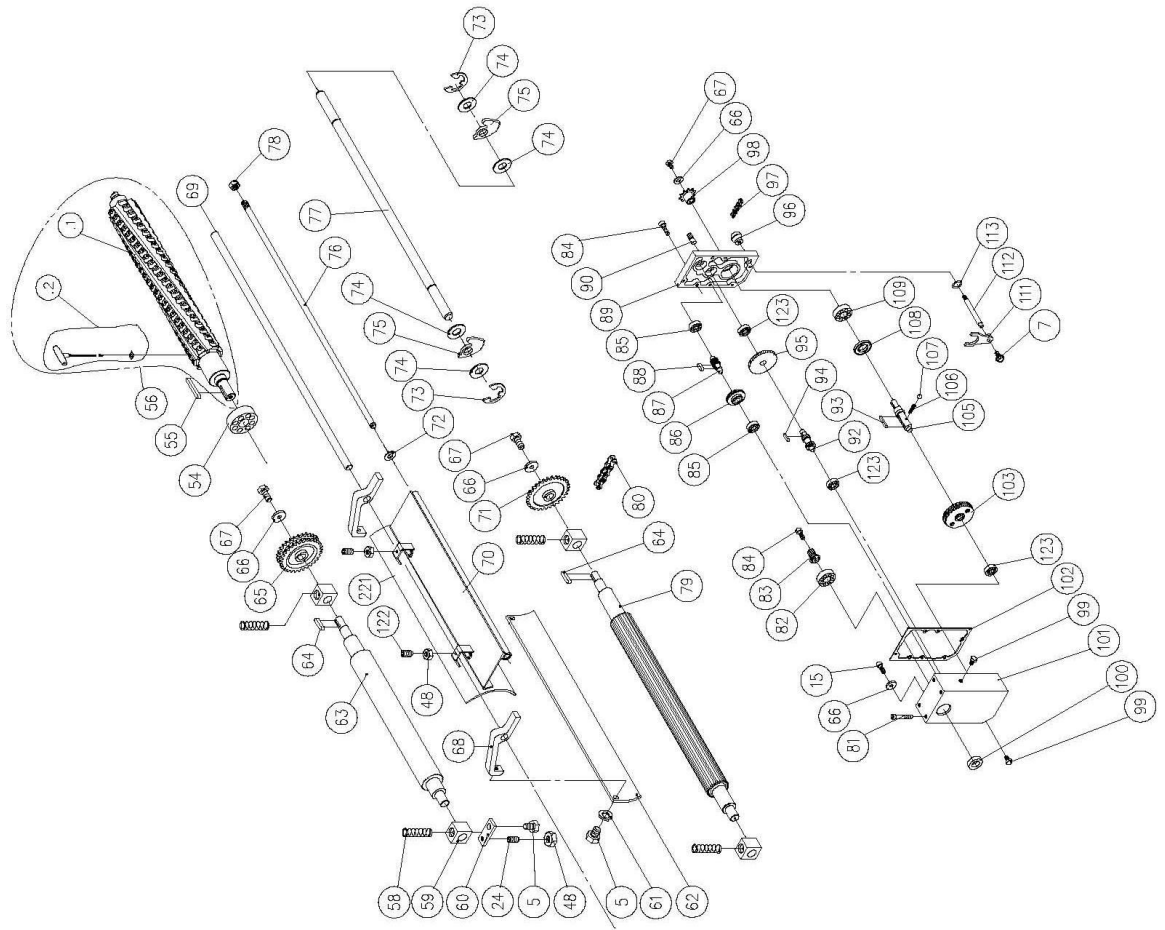

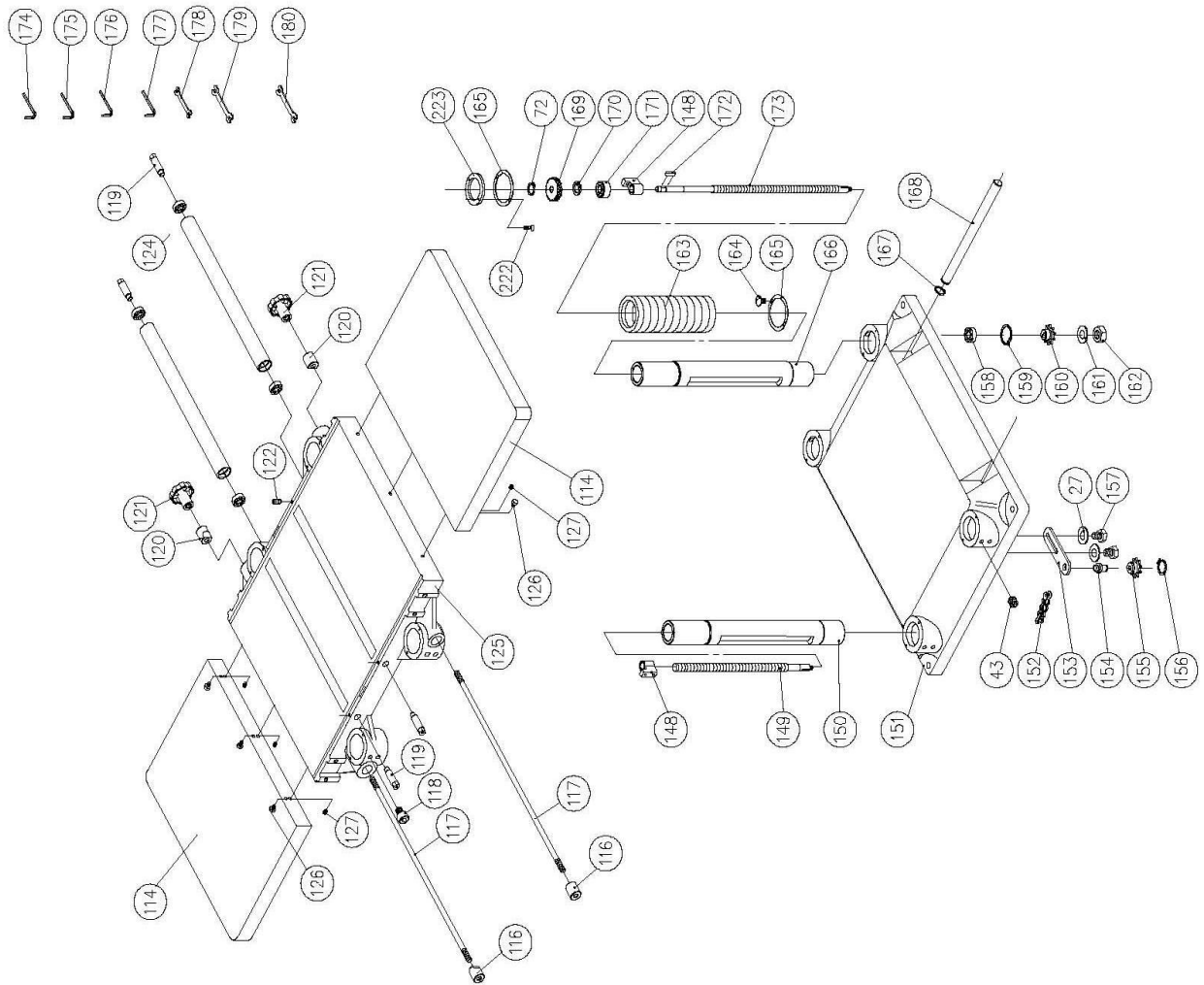

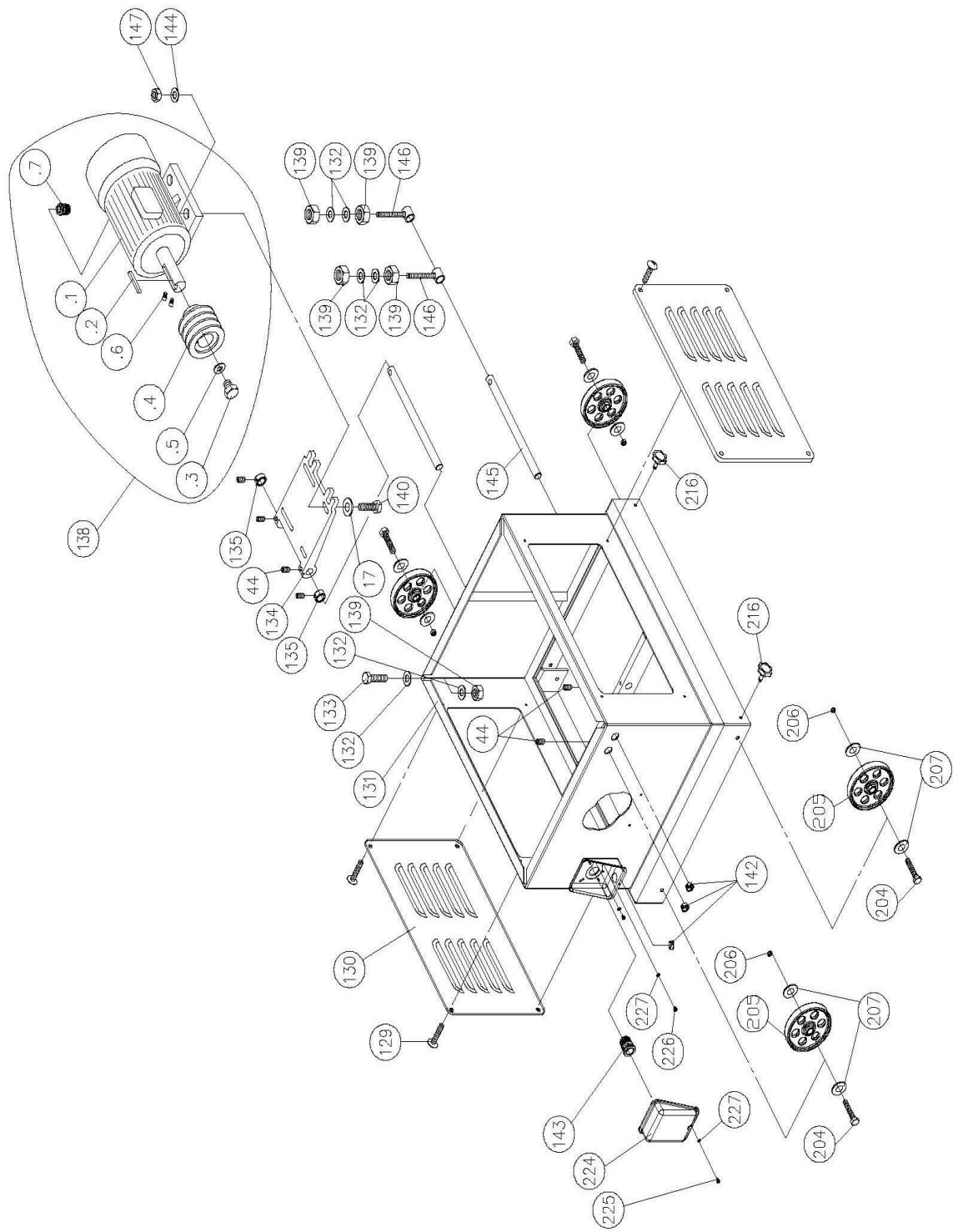

PARTS LIST FOR MPLAN2010-0130

Key	Part No.	Descriptions	Q'ty
1	230118-000	NUT	2
2	170871-000	BELT GUARD FRONT	1
3	014009-000	V-BELT	M57 3
4	380147-901	BOLT	2
5	000003-204	HEX. SCREW	M8*1.25P*20 7
6	006001-043	FLAT WASHER	8.2 *30*4.0t 2
7	000902-202	HEX SCREW W/WASHER	M6*1.0P*12 15
8	170432-000	BELT GUARD REAR	1
9	009005-200	HEX NUT	5/16"-18NC 2
11	050273-901	CUTTERHEAD PULLEY	1
12	170488-000	DUST CHUTE	1
13	000002-201	HEX. SCREW	M6*1.0P*12 4
14	006002-032	FLAT WASHER	6.6*13*1.0t 8
15	000103-103	SOC HD CAP SCREW	M6*1.0P*12 9
16	170494-000	DUST HOOD	1
17	006001-056	FLAT WASHER	8.5*23*2.0t 8
18	000103-106	SOC HD CAP SCREW	M6*1.0P*16 9
19	240017-000	HAND WHEEL	1
20	230114-906	HANDLE	1
21	200021-000	SPONGE	1
22	250172-617	CHIP DEFLECTOR	1
23	270015-901	SPRING PLATE	3
24	000203-106	SET SCREW	M6*1.0P*16 7
25	270017-901	SPRING PLATE	1
26	380200-901	SCREW	4
27	006001-041	FLAT WASHER	8.2*22*3.0t 3
28	170405-901	BRACKET	1
29	290039-901	SHAFT	1
30	130071-000	CHAIN TENSIONER	2
31	360349-902	CHAIN TENSIONER SHAFT	2
32	170473-904	SIDE COVER GUARD	1
33	011004-102	SPRING PIN	6*20 2

34	050292-000	SIDE COVER		1
35	000104-112	SOC HD CAP SCREW	M8*1.25P*40	1
36	280050-000	SPRING		1
Key	Part No.	Descriptions		Q'ty
37	170406-901	HOOK		1
39	170474-901	SHAFT		1
40	000103-110	SOC HD CAP SCREW	M6*1.0P*35	1
41	170475-904	SIDE COVER GUARD		1
42	937574-000	MAGNETIC SWITCH ASSY	5HP.1PH	1
42.1	821007-030	MAGNETIC SWITCH	5HP.1PH	1
42.2	172507-904	SWITCH MOUNTING PLATE		1
42.3	003303-207	ROUND HD SCREW	3/16"-24NC*5/8"	2
42.4	009003-200	HEX NUT	3/16"-24NC	2
42.5	473004-037	MOTOR CORD	SJT12AWG*3C*1450mm	1
42.6	473004-036	POWER CORD	SJT12AWG*3C*2000mm	1
42.7	471004-012	SWITCH CORD	SJT12AWG*1C*150mm	1
42.8	021203-000	RELIEF BUSHING	SW-P6H	3
42.9	006502-100	TOOTH WASHER	5.3*10	2
42.10	021385-000	RELIEF BUSHING	PGA13.5-11B	2
43	000205-101	SET SCREW	M10*1.5P*12	16
44	000204-103	SET SCREW	M8*1.25P*12	7
45	050293-000	HEAD CASTING		1
46	360385-901	SHAFT		2
47	002301-201	Round Head Rivet	2*5	4
48	008005-200	HEX NUT	M6*1.0P	8
49	000203-107	SET SCREW	M6*1.0P*20	2
50	000402-202	FLAT HEAD SCREW	M5*0.8P*8	2
51	170409-901	LIMIT PLATE		1
54	033705-000	BALL BEARING	6206-2NKE	1
55	012204-001	KEY	8*8*36	1
56	922850-000	SHEARTEC 2 CUTTERHEAD ASSY		1
56.1	922851-000	SHEARTEC 2 CUTTERHEAD		1
56.2	850586-000	HARDWARE BAG		1
	040703-000	TORX SCREW DRIVER	T-25	2
	038201-702	TORX SCREW	#10-32UNF*12.5	10

	210114-000	KNIFE	15*15*2.5t	10
58	280051-000	SPRING		4
59	130039-000	BUSHING		4
60	170408-902	RETAINER PLATE		4
61	006305-100	SPRING WASHER	8.2*15.4	3
62	170477-019	PRESSURE PLATE		1
Key	Part No.	Descriptions		Q'ty
63	360405-000	OUTFEED ROLLER		1
64	012003-008	KEY	5*5*22	2
65	070012-000	CHAIN SPROCKET		1
66	006001-020	FLAT WASHER	6.2*20*3.0t	4
67	000002-203	HEX. SCREW	M6*1.0P*16	3
68	070016-025	BRACKET		2
69	360386-000	SHAFT		1
70	170478-019	CHIP BREAKER		1
71	070013-000	CHAIN SPROCKET		1
72	010003-000	RETAINING RING	STW-12	2
73	010209-000	RETAINING RING	ETW-15	2
74	250160-615	SPACER		56
75	172281-905	ANTI-KICK BACK		55
76	360387-000	SHAFT		1
77	360388-000	SHAFT		1
78	008009-200	HEX NUT	M12*1.75P(19B*10H)	2
79	360389-000	INFEED ROLLER		1
80	016308-002	CHAIN	#06B*67P	1
81	000104-114	SOC HD CAP SCREW	M8*1.25P*50	4
82	030109-000	BALL BEARING	6204-ZZ	1
83	320196-000	GEAR		1
84	000103-108	SOC HD CAP SCREW	M6*1.0P*25	5
85	030701-000	BALL BEARING	6201	2
86	320197-000	GEAR		1
87	320160-000	SHAFT		1
88	012003-003	KEY	5*5*12	1
89	050280-000	GEARBOX COVER		1
90	360355-901	PIN		2

91	006002-046	FLAT WASHER	8.5*16*1.5t	2
92	320205-000	SHAFT		1
93	012004-003	KEY	6*6*40	1
94	012003-002	KEY	5*5*10	1
95	320198-000	GEAR		1
96	250372-615	KNOB		1
97	016304-000	CHAIN	#06B*50P	1
98	150008-000	CHAIN SPROCKET		1
99	043401-000	PLUG	PT1/4"-19牙	2
Key	Part No.	Descriptions		Q'ty
100	043608-000	OIL SEAL	TC28*40*8	1
101	050281-000	GEARBOX		1
102	340012-615	GEARBOX GASKET		1
103	922351-000	GEAR ASSEMBLY		1
104	010102-000	RETAINING RING	RTW-32	1
105	360357-901	SHAFT		1
106	280052-000	SPRING		1
107	017002-000	STEEL BALL	6	1
108	043505-000	OIL SEAL	SC25*47*6	1
109	030306-000	BALL BEARING	6204Z(A)	1
110	006001-032	FLAT WASHER	6.6*13*1.0t	7
111	070014-000	SHIFTING CLAW		1
112	360358-901	SHAFT		1
113	043303-000	RETAINING RING	P12	1
114	050301-000	EXTENSION TABLE		2
116	130038-000	COLUMN LOCK BUSHING		2
117	360390-000	SHAFT		2
118	000104-104	SOC HD CAP SCREW	M8*1.25P*16	8
119	360391-000	ECCENTRIC SHAFT		4
120	130037-000	COLUMN LOCK BUSHING		2
121	230115-000	KNOB		2
122	000203-104	SET SCREW	M6*1.0P*12	6
123	030304-000	BALL BEARING	6201Z	4
124	921208-000	ROLLER W/BEARING		2
125	050302-000	TABLE		1

126	000003-105	HEX. SCREW	M8*1.25P*25	6
127	000204-105	SET SCREW	M8*1.25P*20	6
129	000403-204	FLAT HEAD SCREW	M6*1.0P*20	8
130	170479-000	STAND ACCESS PANEL		2
131	922874-000	STAND		1
132	006002-091	FLAT WASHER	13*28*3.0t	13
133	000005-202	HEX. SCREW	M12*1.75P*50	4
134	050321-008	MOTOR PLATE		1
135	190074-901	SPACER		2
138	900755-000	MOTOR ASSY	5HP*230V*60HZ*1PH	1
138.1	593012-000	MOTOR	5HP*230V*60HZ*1PH	1
138.2	012202-002	KEY	5*5*30	1
Key	Part No.	Descriptions		Q'ty
138.3	000003-204	HEX. SCREW	M8*1.25P*20	1
138.4	050351-902	MOTOR PULLEY		1
138.5	006001-043	FLAT WASHER	8.2*30*4.0t	1
138.6	021203-000	RELIEF BUSHING	SW-P6H	2
138.7	021369-000	RELIEF BUSHING	PGA13.5-11B	1
139	008009-100	HEX NUT	M12*1.75P	8
140	000003-208	HEX. SCREW	M8*1.25P*40	4
142	021801-000	RELIEF BUSHING	NB-1722	3
143	021369-000	RELIEF BUSHING	PGA13.5-11B	1
144	006001-046	FLAT WASHER	8.5*16*1.5t	4
145	360394-000	MOTOR MOUNTING SHAFT		2
146	380249-901	MOTOR MOUNT TENSION SHAFT ASSEMBLY		2
147	008006-200	HEX NUT	M8*1.25P	4
148	130045-000	NUT		4
149	360395-000	COLUMN SHAFT		3
150	050296-000	COLUMN		3
151	050297-000	BASE CASTING		1
152	016004-000	CHAIN	#40*166P	1
153	170413-901	CHAIN TENSIONER BRACKET		1
154	360362-902	SPROCKET SHAFT		1
155	150011-000	CHAIN SPROCKET		1

156	010006-000	RETAINING RING	STW-15	1
157	000003-205	HEX. SCREW	M8*1.25P*25	2
158	030305-000	BALL BEARING	6202Z(A)	4
159	010103-000	RETAINING RING	RTW-35	4
160	150012-000	CHAIN SPROCKET		4
161	006001-078	FLAT WASHER	10.5*19*1.5t	4
162	008008-100	HEX NUT	M10*1.25P	4
163	250173-000	EXPANSION BEND		8
164	001104-502	ROUND HEAD TAPPING SCREW	M5*2.12P*10	30
165	170481-901	FIXING BUSH		16
166	050298-000	MAIN COLUMN		1
167	010202-000	RETAINING RING	ETW-17	4
168	360396-902	ROD		4
169	320203-000	WORM GEAR		1
170	010104-000	RETAINING RING	RTW-38	1
171	130046-000	BUSHING		1
Key	Part No.	Descriptions		Q'ty
172	012002-004	KEY	4*4*10	2
173	360397-000	ELEVATING SCREW		1
174	040003-000	HEX. WRENCH	3mm	1
175	040004-000	HEX. WRENCH	4mm	1
176	040005-000	HEX. WRENCH	5mm	1
177	040006-000	HEX. WRENCH	6mm	1
178	040201-000	WRENCH BOX	8*10	1
179	040204-000	WRENCH BOX	12*14	1
180	040206-000	WRENCH BOX	17*19	1
188	050299-000	ROLLER BRACKET		3
189	360398-902	ROLLER		2
190	050300-000	ELEVATING SCREW GEARBOX		1
191	000103-113	SOC HD CAP SCREW	M6*1.0P*50	3
192	320204-000	SHAFT		1
194	190008-901	SPACER		1
200	000902-203	HEX SCREW W/WASHER	M6*1.0P*16	5
201	000103-102	SOC HD CAP SCREW	M6*1.0P*10	2
204	003005-206	HEX. SCREW	3/8"-16NC*2-1/2"	4

205	250402-000	WHEEL		4
206	009102-200	HEX NUT	3/8"-16NC	4
207	006002-077	FLAT WASHER	10.5*19*1.0t	8
208	921246-000	DIGITAL READ OUT	9 inch	1
208.1	921245-000	DIGITAL READ OUT	9 inch	1
208.2	171370-904	BRACKET		1
208.3	171371-904	BRACKET		1
208.4	000205-102	SET SCREW	M10*1.5P*30	1
208.5	008007-100	HEX NUT	M10*1.5P	1
208.6	006001-045	FLAT WASHER	8.5*16*1.0t	1
208.7	000104-110	SOC HD CAP SCREW	M8*1.25P*30	1
208.8	006001-001	FLAT WASHER	4.3*10*1.0t	1
208.9	000302-101	ROUND HD SCREW	M4*0.7P*6	1
208.10	000301-101	ROUND HD SCREW	M3*0.5P*6	2
216	004001-101	KNOB	5/16"-18NC*3/4"	2
217	000002-201	HEX. SCREW	M6*1.0P*12	6
219	048201-204	HEX HEAD SCREW	M8*1.25P*30	1
220	003905-201	WOOD SCREW	1/4"-20NC-1"	16
221	200057-646	SPONGE	3/8"*1/2"*525L	1
Key	Part No.	Descriptions		Q'ty
222	000303-105	ROUND HD SCREW	M5*0.8P*15	2
223	380168-901	WASHER		1
224	490124-000	TERMNAL COVER		1
225	003303-102	ROUND HD SCREW	3/16"-24NC*1/4"	1
226	000303-103	ROUND HD SCREW	M5*0.8P*10	2
227	006502-100	TOOTH WASHER	5.3*10	3

Laguna Tools

MPLAN1510-0130: Platinum Series 16" Planer



Dear Woodworker:

Thank you for your purchase and welcome to the Laguna Tools group of discriminating woodworkers. I understand that you have a choice of where to purchase your machines and appreciate the confidence you have in our products.

Every machine sold by Laguna Tools has been carefully designed and well thought through from a woodworker's perspective. I cut on our bandsaws, lathes, table saws and combination machines. Through my hands-on experience, I work hard to make our machines better. I strive to give you machines that inspire you to create works of art. Machines that are a joy to run and work on. Machines that encourage your performance.

Today, we offer high-performance machines with innovative solutions that meet the needs of woodworkers and their ever-evolving craft.

I started Laguna Tools as a woodworker; I still am.

Thank you again for becoming a Laguna Tools customer.

Torben Helshoj

President and Founder – Laguna Tools

Imagination, Innovation and Invention at work.

Table of contents

	Page number
Safety Rules	4
Warranty	5
Noise emission	6
Specification sheet	6
Receiving your planer	7
Introduction to your planer	7
What you will receive with the planer	8
Parts of the planer	9
Where to locate your planer	10
Unpacking your planer	10
Assembly and setup	11
Running and adjusting the planer	14
Maintenance	19
Troubleshooting	21
Exploded view drawings	

Safety Rules

As with all machinery, there are certain hazards involved with the operation and use. Using it with caution will considerably lessen the possibility of personal injury. However, if normal safety precautions are overlooked or ignored, personal injury to the operator may result. If you have any questions relative to the installation and operation, do not use the equipment until you have contacted your supplying distributor.

Read carefully before operating the machine.

- 1. Keep the working area clean and be sure adequate lighting is available.**
- 2. Do not wear loose clothing, gloves, bracelets, necklaces or ornaments. Wear face, eye, respiratory and body protection devices as indicated for the operation or environment.**
- 3. Be sure that the power is disconnected from the machine before tools are serviced or an attachment is to be fitted or removed.**
- 4. Never leave the machine with the power on.**
- 5. Do not use dull, gummy or cracked cutting tools.**
- 6. Be sure that the keys and adjusting wrenches have been removed and all the nuts and bolts are secured.**

Limited Warranty

New woodworking machines sold by Laguna Tools carry a one-year warranty from the date of shipping. Laguna Tools guarantees all new machines sold to be free of manufacturers' defective workmanship, parts and materials.

We will repair or replace, without charge, any parts determined by Laguna Tools, Inc., to be a manufacturer's defect. We require the defective item/part to be returned to Laguna Tools. In the event the item/part is determined to be damaged due to lack of maintenance, cleaning or misuse/abuse, the customer will be responsible for the cost to replace the item/part, plus all related shipping charges.

This limited warranty does not apply to natural disasters, acts of terrorism, normal wear and tear, product failure due to lack of maintenance or cleaning, damage caused by accident, neglect, lack of or inadequate dust collection, misuse/abuse or damage caused when repair or alterations have been made or attempted by others. Laguna Tools, Inc. is not responsible for additional tools or modifications sold or performed (other than from/by Laguna Tools, Inc.) on any Laguna Tools, Inc. woodworking machine. Warranty may be voided upon the addition of such noted tools and/or modifications, determined on a case-by-case basis.

Normal user alignment, adjustment, tuning and machine settings are not covered by this warranty. It is the responsibility of the user to understand basic woodworking machinery settings and procedures and to properly maintain the equipment in accordance with the standards provided by the manufacturer.

Parts, under warranty, are shipped at Laguna Tools, Inc's cost either by common carrier, FedEx Ground service or similar method.

Technical support to install replacement parts is primarily provided by phone, fax, or e-mail. The labour required to install replacement parts is the responsibility of the user.

Laguna Tools is not responsible for damage or loss caused by a freight company or other circumstances not in our control.

Only new machines sold to the original owner are covered by this warranty.

For warranty repair information, call 1-800-332-4094.

Copyright 2010 Laguna Tools, Inc.

** Warning – no portion of these materials may be reproduced without written approval from Laguna Tools, Inc.

All documentation subject to change without notice

Noise emission.

Notes concerning noise emission

Given that there exists a relationship between noise level and exposure times, it is not precise enough to determine the need for supplementary precautions. The factors affecting the true level of exposure to operators are clearly the amount of time exposed, the characteristics of working environment, other sources of dust and noise, etc. For example, adjacent machines, in other words, affect the level of ambient noise. It is possible that exposure level limits will vary from country to country.

Specification sheet.

Machine	Platinum Series 16" Planer MPLAN1510- 0130
Motor	3hp
Planer table size	25" x 20"
Cutter head	Shear-Tec 6 Row Spiral
Dust chute diameter	4 inches
Cut Capacity:	16" x 8" (W x H)
Maximum planing depth	1/8 inch
Feed speeds	16 TO 20 feet per min
Cutter speed	3420 rpm
Volts	220 V single phase
Weight net	560 lbs

Receiving your machine.

Note. It is probable that your machine will be delivered by a third party. Before you unpack your new machine, you will need to first inspect the packing, invoice and shipping documents supplied by the driver.

Ensure that there is no visible damage to the packing or the machine. You need to do this prior to the driver leaving. All damage must be noted on the delivery documents and signed by you and the delivery driver. You must then contact the seller (Laguna Tools) within 24 hours.

Introduction to planers

The planer is designed to give you years of safe service. Read this owner's manual in its entirety before assembly or use.

The planer is generally defined as a machine that cuts planks of wood smooth and parallel. There are many types of cutter head, and this machine uses an inserted cutter type. The insert cutters main advantage is to reduce tear out of the grain, but the finish is not as smooth as the parallel blade system. It is well within the capabilities of a belt sander to give a professional finish to the jointed plank.



The parallel blade system, gives a finish without the lines that the insert cutter system gives, but, is susceptible to tear out, especially on planks with knots. On balance, it is better to use a machine with the insert cutters than the parallel blades, as it greatly reduces the risks of having to scrap valuable wood, or spending excessive time sanding tear out marks.

Additional Instructions for the use of planers

Like all machines, there is danger associated with the machine. Injury is frequently caused by lack of knowledge or familiarity. Use this machine with respect. If normal safety precautions are overlooked or ignored, serious personal injury may occur.

1. Supporting the work.

Only make cuts if the work piece is stable and never attempt to cut unstable planks, or injury may occur.

2. Cutting depth.

Never exceed the maximum cutting depth as stated in the specification for your machine. It is far better to take several small cuts, rather than large cuts.

3. Direction of cut.

Planing against the grain is dangerous and could produce chatter or excessive chip out. Always plane with the grain.

4. Guards.

Guards are designed to reduce the risk of injury. **Always use the guards.**

5. Stock.

Your safety will be greatly enhanced if you only use good lumber. Only work with lumber after you have inspected it completely. Staples, nails, loose knots and any other metal in the plank will damage your cutter head and could cause injury or fire. If you have any question about a piece of lumber, do not use it.

What you will receive with the planer.

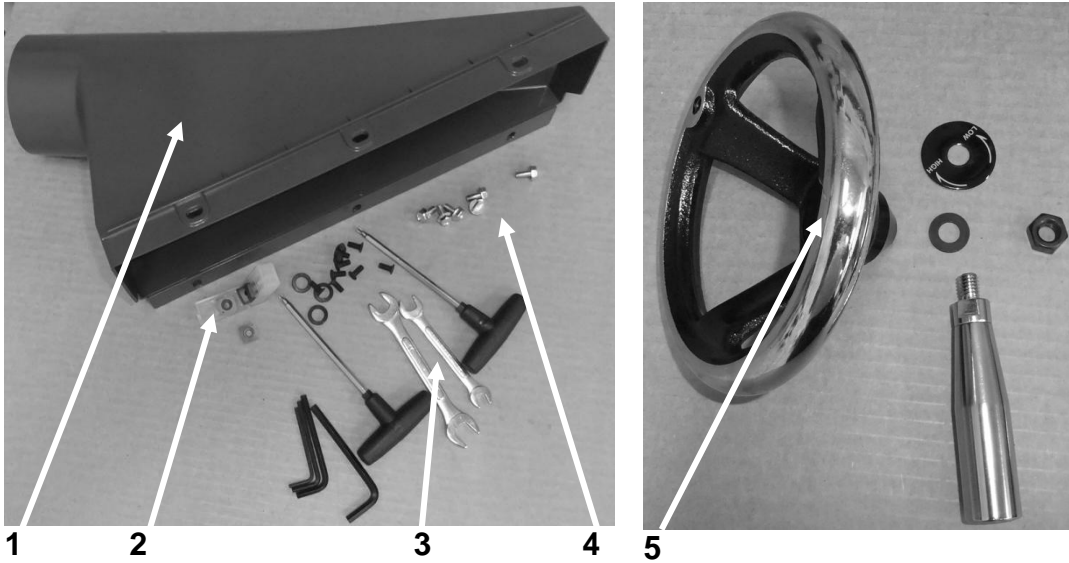

1. Dust shute.
2. Spare cutter teeth
3. Tools
4. Screws.
5. Handle.
6. Extension tables.

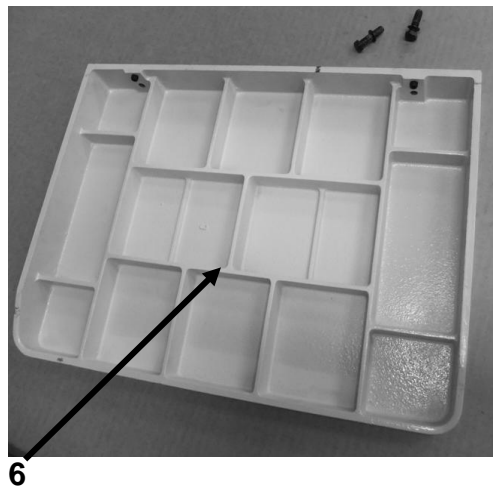

Parts of the planer/moulder.

The planer/moulder major parts are discussed in this manual. If you are not familiar with the planer/moulder, take the time to read this section and become familiar with the machine.

1. Body.

The body is made from pressed steel and is designed to give the machine support and rigidity.

2. Lifting rods.

The lifting rods are extendable from the machine. Lifting straps can be attached to the rods when lifting or moving the machine.

3. Support rollers.

The support rollers, support the work piece when returning back for additional cuts.

4. Start/stop switch.

5. Power cable.

No power cable is supplied with the machine. A power cable will have to be connected to the termination box at the back of the machine.

6. Table.

The table is made from cast iron and supports the work while it is being machined. The table has a fine ground finish.

7. Dust chute.

A 4-inch diameter dust chute is provided. The dust chute must be connected to a dust collector with a minimum capacity of 1000 c.f.m. The machine produces a lot of sawdust and wood chippings; the stronger the dust collector the better.

8. Table adjusting handle.

The table adjusting handle raises and lowers the table.



Where to locate your machine.

Before you remove your machine from the pallet, select the area where you will use your machine. There are no hard-and-fast rules for its location, but below are a few guidelines.

1. There should be an area at the front and back of the machine suitable for the length of wood that you will be machining.
2. Adequate lighting. The better the lighting, the more accurate and safely you will be able to work.
3. Solid floor. You should select a solid, flat floor, preferably concrete or something similar.
4. Close to power source and dust collection.

Unpacking your machine.

To unpack your machine, you will need tin snips, knife and a wrench.

1. Using the tin snips, cut the banding that is securing the machine to the pallet (if fitted).

WARNING: EXTREME CAUTION MUST BE USED BECAUSE THE BANDING WILL SPRING AND COULD CAUSE INJURY.

2. Lift the box off and discard.
3. Using the knife, cut the plastic wrap from the top. The accessories that were ordered could be attached to the side of the machine, and extreme caution must be taken so that the parts do not fall and cause injury or damage. Remove them and set aside.
4. Some of the parts supplied with the machine may be shipped inside the machine. To access these parts, remove the machine side panels.
5. Remove the base mounting bolts that secure the machine to the pallet. The mounting bolts are accessed from underside of the pallet [If fitted].

6. The machine can be lifted using a forklift truck or hoist. To lift the machine off the pallet using a sling, pull the lifting rods out from the machine's main body. Fit the sling around the sling rods and lift the machine off the pallet with a hoist. The hoist must have a lifting capacity of no less than 2000 lbs. Remove the pallet and lower the machine to the floor.

Note. The machine is heavy, and if you have any doubt about the described procedure, seek

professional assistance. Do not attempt any procedure that you feel is unsafe or that you do not have the physical capability of achieving.



Lifting rods

Assembly and setup.

Mobility kit.

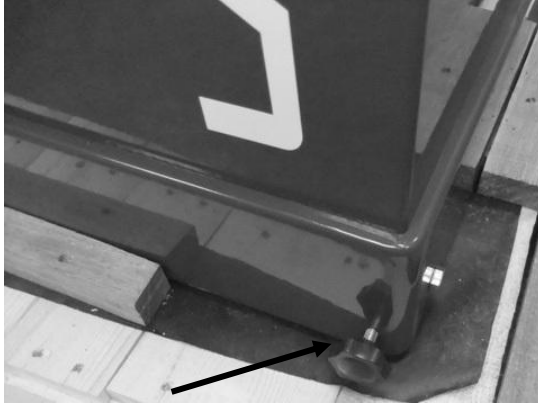

Mobility clamp screw

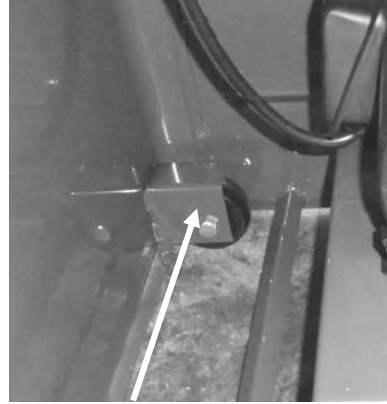

Mobility wheel

The mobility wheels come pre-fitted to the base of the machine.
The wheels are locked by tightening the clamp screws on the outside of the body.

Fitting the dust chute.

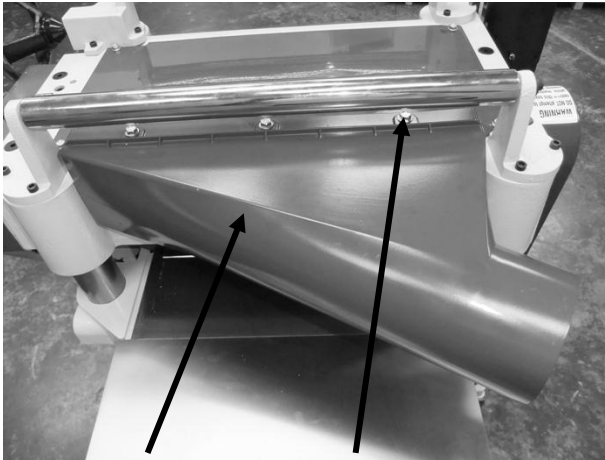

Dust chute Upper fixing screws



Lower fixing screws

Note. The dust chute has to be removed to access the cutter head.
Attach the dust chute with the upper and lower fixing screws.

Connecting the electrical supply.

Note. A qualified electrician must carry out the installation.

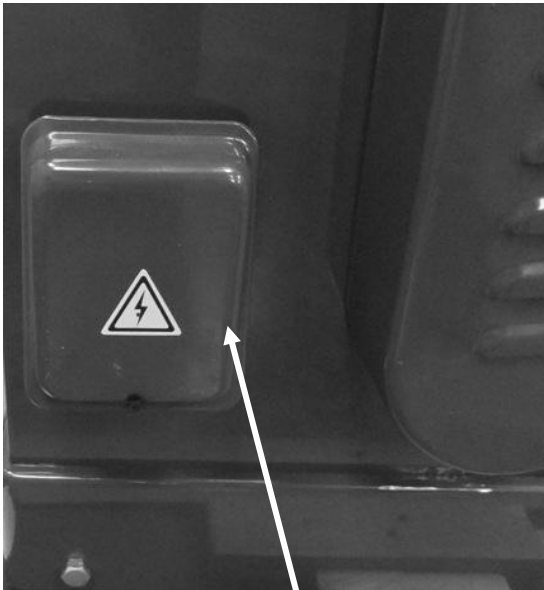

Power termination box



Cover removed

Ensure that the electrical supply corresponds with that of the machine (single-phase 220 V).

It is recommended that you use a 30-amp mains breaker.

The mains cable must be connected into the power termination box.

Note. The machine is not normally supplied with an electrical cable or plug, as the type of plug and the length of the cable will be dependent on the installation.

Connecting the dust collection.

Connect a 4-inch flexible hose between the dust collection hood and your dust collector. Once fitted, pull on the hose to ensure that the connection is tight. You do not want it to come off during production.

Note. You will need a dust collection system with a minimum of 1000-cubic-foot-per-minute capacity. The stronger the dust collection the better, as the machine is capable of producing a lot of waste.

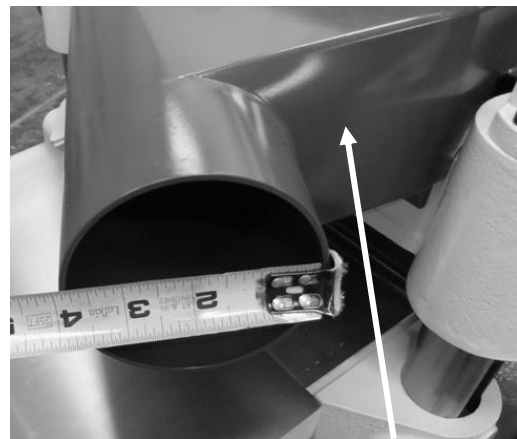

Dust collection hood

Fitting the vertical adjustment handle.



Key



Handle

1. Clean the shaft and the key.
2. Slide the handle onto the shaft. Ensure that the key lines up with the key way in the handle, and that the key is bottomed out in the shaft slot. You may have to gently tap the handle, as the key may be a tight fit.
3. Fit the washer and nut as shown.

Fitting the extension tables.

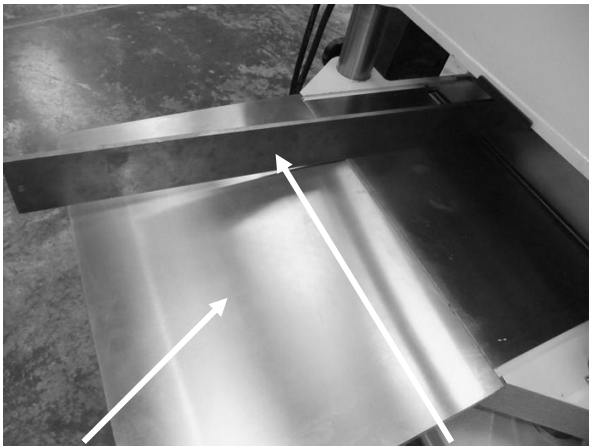

Extension table

Straight edge

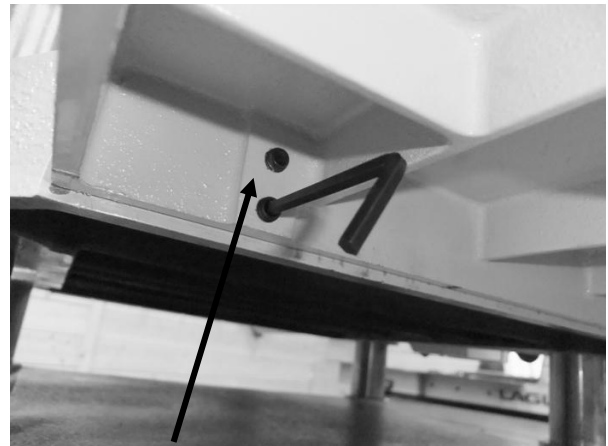

Fixing and jacking screws

There are two extension tables, one on either side of the machine. The tables are attached to the main table with fixing screws, and jacked level with the main table by allen set screws.

1. Attach the extension tables to the main table with the fixing bolts.
2. Place a straight edge on both the main table, and one of the extension tables.

3. Bring the extension table up level with the main table [check both sides of the table].

4. By loosening one of the fixing bolts and tightening the jacking screw, the table can be jacked parallel with the main table. This process must be done slowly jacking a small amount each side so that no excessive strain is put on the table flange. Excessive jacking could crack the cast iron table.

5. Once the tables are parallel, check that both tables are still level and adjust if required.

6. Repeat for the other extension table.

Note. The tables must be checked at both sides.



Straight edge

Cleaning the machine.

The machine is shipped with the non-painted surfaces protected from rust by a film of grease.

The grease must be removed with WD40 or similar, as it attracts saw dust and dirt. The surfaces should then be coated with a Teflon lubricant or similar. Teflon tends to dry and will not attract sawdust and dirt. To reduce table friction, it is recommended that the table is polished with a good-quality wax. This will also afford a degree of protection from rust.

Anti-kickback teeth.

The anti-kickback teeth must be free to move, or they will not fulfill their function.

With the power disconnected, check that all the teeth move freely. If they do not, lubricate with Teflon-based lubricant.



Anti-kickback teeth

Running and adjusting the machine.

Adjustments.

Note. The machine has had all its functions calibrated at the factory, but due to shipping conditions, some movement may have taken place. This is unavoidable, and it is therefore recommended that the following checks are made prior to starting

production. As the machine is used, some functions may move, and it is good practice to know the process for adjusting the machine prior to production.

Test Run

Now that the assembly is complete it is time to conduct a test run.

During the test run you will check the following points.

1. Motor starts and runs smoothly.
2. That the stop buttons function correctly.

Before you run the machine check the following.

1. All the tools have been removed from the machine.
2. All the guards are in place.
3. You are wearing the appropriate safety equipment.
4. You have read and understood the instruction manual.

Note. If any of the below functions fail to operate correctly, the fault must be corrected prior to continuing to the next test. Any investigation to find or correct a fault must be conducted with the power disconnected.

1. Start the machine by pressing the green start button.

The machine should run smoothly with little or no vibration.

2. Press the red stop button. The machine should slow down and stop.

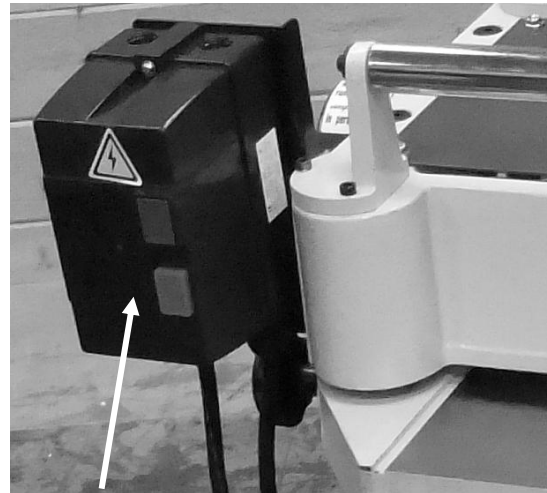

Stop and start buttons

Power feed.

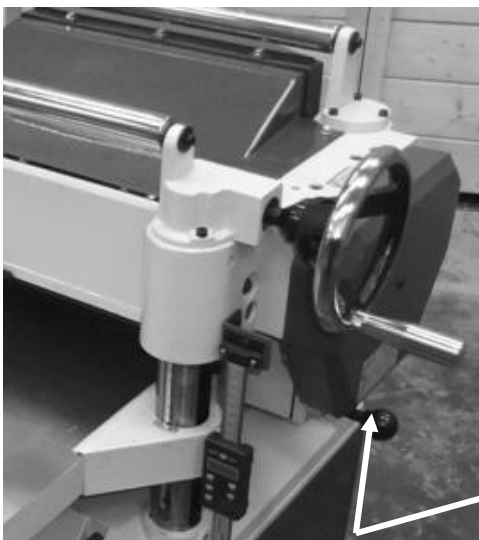

Power feed handle

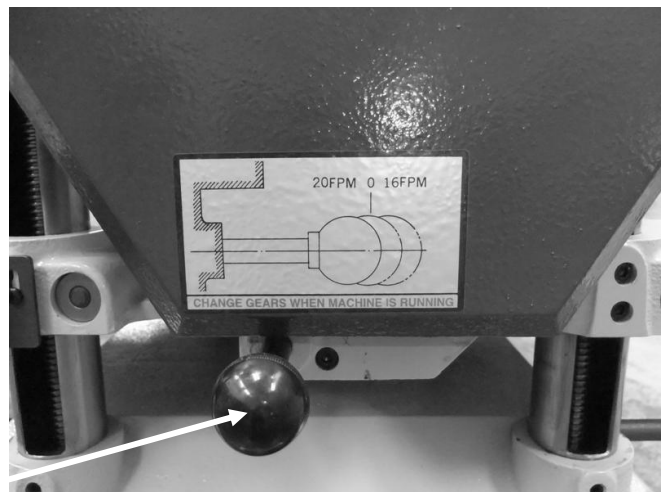

To engage the power feed rollers, pull or push the power feed handle with the motor running. Pushing the handle in, selects 20 FPM and pulling it out selects 16 FPM. The centre position is neutral.

Note. Only engage and disengage the power feed with the motor running.

Adjusting the table height.



Table height adjusting handle



Height scale

Scale fixing screw

Height digital read out

To adjust the height of the table, rotate the height adjusting handle. Once at the required height, clamp the table in position with the table clamp handle.

The height scale comes factory set, and should not need adjustment. If movement has taken place during shipping, adjust as follows.

1. Plane a plank of wood to a convenient thickness.
2. Check the thickness of the plank.
3. Check the reading on the scale.
4. If adjustment is required, loosen the fixing screws, readjust the position of the scale, and tighten the screws.

Set the digital read out as follows.

1. Skim the job in hand.
2. Measure the thickness of the job.
3. Press and hold for a few seconds the set button. The display will go to zero.
4. Adjust the table for the amount that you require to be removed.

Note. Always clamp the table in position with the clamp handles after table adjustment.

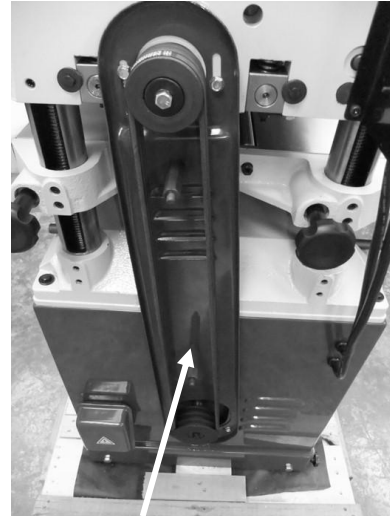

Table clamp handle

Adjusting the drive belts.



Motor adjuster



Cover removed

The drive belts should be checked after running the machine for approximately 10 hours. The belts bed into the pulleys and will slacken off slightly. If they are not adjusted, slippage may accrue, and this will cause early belt failure. There should be approximately 3/16" deflection when the belt is pressed with moderate finger pressure.

To increase the tension on the belts, loosen the motor adjuster lower nut. Tighten the upper nut to increase the belt pressure.

Note. To access the drive belts, and motor, remove the side cover, and belt cover.

Note. Disconnect the power to the machine prior to conducting machine adjustments or repairs.

Fitting teeth to the Sher tec cutter head

The carbide cutter head [Sher Tec] has multiple teeth, which have 4 cutting edges. When they are blunt, or damaged, the teeth can be rotated as follows,

Note. You will notice that each cutter tooth has a registration dot, to enable you to ensure that the teeth are moved round in the same direction.

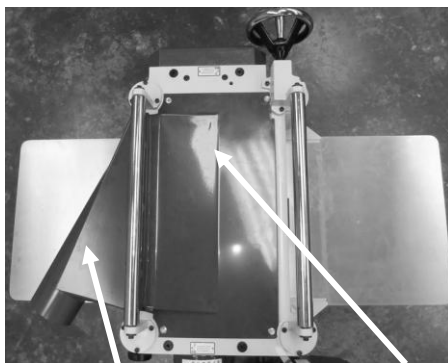

Dust shute

Cover



Registration dot

1. With the power disconnected from the machine. Remove the cutter head cover, and the dust shute.

2 Loosen the tooth with the special allen key.

2. Lift the tooth and rotate to the new cutting face.

Note. Take special care to clean the tooth and its mating surface. Any dirt or sawdust that is trapped under the tooth will cause it to be at a different height to the other teeth and degrade the surface finish when you start machining. This will result in you having to take all

the teeth out, and clean the teeth, and the mating surfaces again. This is very frustrating and a waste of time, take your time and ensure that you are very thorough with cleaning.

3. Lower the tooth into the cutter head and clamp with the allen key.

Note. Only move all the teeth to a new cutting edge. Do not move less than all the teeth.

Note. The carbide cutter head has several advantages over the parallel blade type cutter head.

1. The teeth are carbide and will last longer than high speed steel parallel blades.

2. There is less chance of tare out.

The disadvantage is that they are initially more expensive and that the surface finish is slightly wavy. This is caused because the teeth have a very slight radius. This waviness is easily removed by a light sanding.

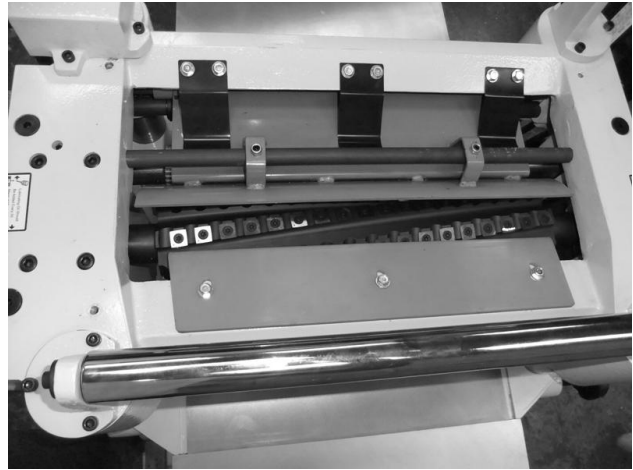

Cover removed

Maintenance.

As with any machine, to ensure optimal performance, you must conduct regular maintenance.

Daily checks.

1. Clean the machine and lubricate unpainted surfaces with a Teflon-based lubricant. Wipe off any excess and buff with a dry polishing cloth. This will reduce the likelihood of rust forming and reduce the friction on the tables as the wood is machined.
2. Check cutter blades for chips and dullness.
3. Generally inspect the machine for damage and loose or worn parts.

Weekly checks.

1. Clean the cutter head.
2. Check cutter blades for chips and dullness.
3. Generally inspect the machine for damage and loose or worn parts.
4. Check the dust extraction for blockages and any large bits that could cause blockages.

Monthly checks.

1. Check the motor drive belts for wear, splits and cuts.
2. Clean the motor compartment and the motor to ensure that the motor cooling fins work efficiently.
3. Clean and lubricate the drive chains and cogs.
4. Generally inspect the machine for damage and loose or worn parts.

Note. It is recommended that you use a Teflon-based lubricant.

Drive belt replacement.

Note. Disconnect the power to the machine before conducting any maintenance on the machine.



Motor adjuster



Cover removed

1. Remove the side cover to access the motor.
2. Remove the belt guard to access the drive belts.
3. Loosen the motor adjustor nuts.
4. Remove the drive belts.
5. Fit the new belts.
6. Re-tension the belts by tightening the top motor adjusting nut. There should be a 3/16" deflection when the belt is pressed with moderate finger pressure. Tighten the lock nut.
7. The drive belts should be checked after running the machine for approximately 10 hours. The belts bed into the pulleys and will slacken off slightly. If they are not adjusted, slippage may accrue, and this will cause early belt failure. There should be a 3/16" deflection when the belt is pressed with moderate finger pressure.
8. Refit the side cover and belt guard.

Note. Your machine is fitted with a multi drive belt system. Always replace all the belts with a matched set. **Never** replace only one belt, as this will cause vibration, excessive wear to bearings and result in a poor work finish.

Power drive maintenance

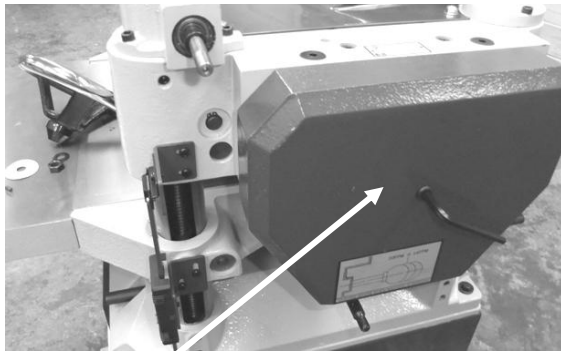

Power drive cover

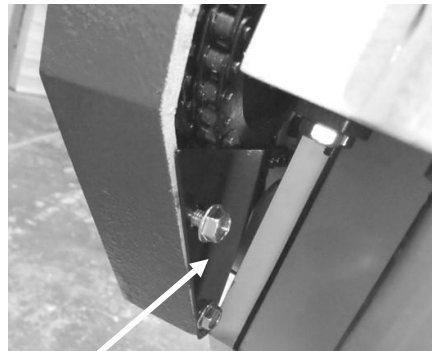

Cover plate

To access the power drive chain, the gear box cover has to be removed, as detailed below.

1. Remove the height adjusting handle.
2. Remove the power drive engage disengage knob.
3. Remove the power drive cover fixing screw.
4. Lift the power drive cover to expose the cover plate, and remove the top fixing screw. Loosen the lower screw and slide the cover plate down.

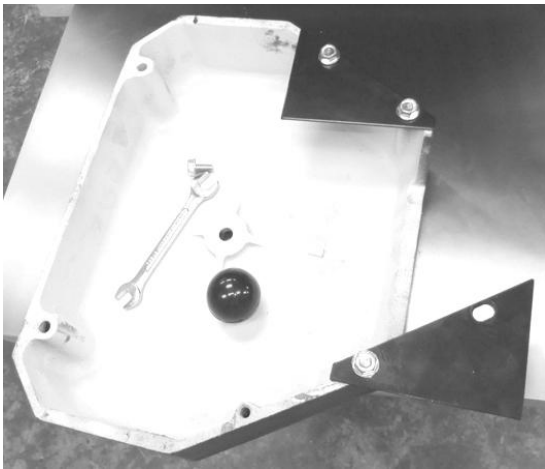

Power drive cover removed

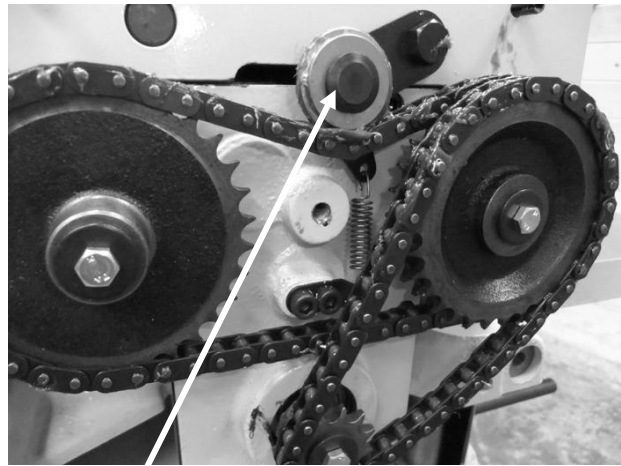

Chain tension wheel

5. Remove the power drive cover.

6. Check that the chain tension wheel is free to move and that the chains are clean and lubricated.

7. Reassemble.

Lubricating the machine.

Lubrication oil to be added every 30 hours of operation, to both sets of holes as shown.

Note. All the bearings are sealed for life and do not require lubrication. If a bearing is noisy, do not try to re-lubricate but replace it.

Note. It is recommended that you use a Teflon-based lubricant, as it tends to dry and therefore will attract less sawdust and dirt. Lubricate the drive chains and cogs.



Lubrication holes

Drive roller and anti-kickback teeth adjustment.

The drive roller pressure roller and anti-kickback teeth must sit below the cutter head teeth.

The drive roller and pressure rollers are sprung loaded and as the wood passes move vertically. This provides the correct amount of pressure to transport the wood past the cutter head and keep the wood firmly in contact with the bed of the machine.

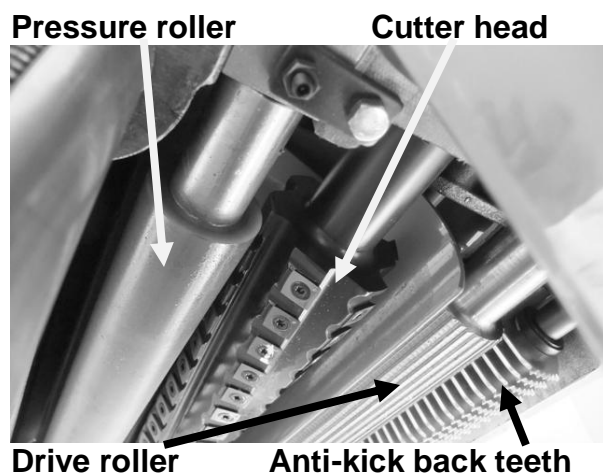

Drive roller

Anti-kick back teeth

The drive roller, pressure roller and anti-kickback teeth come factory set but should adjustment be required proceed as follows.

Loosen the lock nut and move the adjusting screw. Remember to tighten the lock nut once the adjustment has been completed.

Note. There is a screw both sides of the machine for both rollers [four adjusting screws in total]. If parallel adjustment is required both screws must be moved the same amount for each roller.

To adjust for parallel it is suggested that a block of parallel wood is used and placed under the relevant roller at one end. The bed of the machine is then moved vertically so that the wood just touches the relevant roller. Check both sides of the roller that you are adjusting.

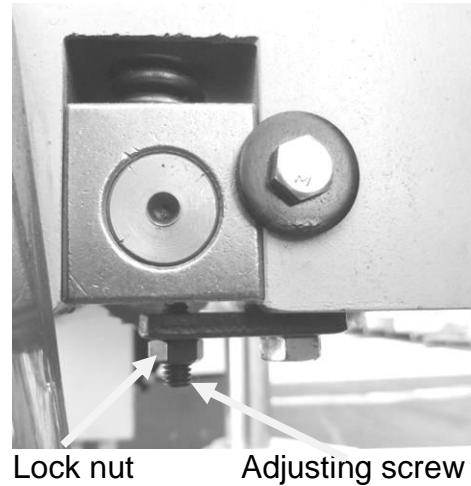

Troubleshooting and fault finding.

Problem	Cause	Corrective action
Motor will not start or fuses or circuit breakers blow.	1. Short circuit	2. Repair or replace short circuit item.
	2. Start capacitor faulty.	3. Fit new capacitor.
	3. Motor thermal protection circuit breaker faulty, or motor is at fault.	4. Replace thermal protection circuit breaker in motor or replace motor.
	4. Open circuit in motor or loose connections.	5. Replace or repair motor or loose connection.
Fuses or circuit breakers blow.	1. Motor drawing excessive current.	1. Repair or replace motor.
	2. Cutter head or motor jammed.	2. Remove jam.
	3. Short circuit.	3. Repair or replace short circuit item.
Motor will not develop full power or motor speed slows with load, over heats or stalls.	1. Motor run capacitor faulty.	1. Replace the capacitor.
	2. Machine overloaded.	2. Take smaller cuts.
	3. Motor overheating.	3. Clean motor, taking care to make sure that all the cooling fins are clean.
	4. Short circuit in motor or loose connections.	4. Repair or replace motor or loose connections.
Cutter head slows or belt squeals when cutting.	1. V-belts loose.	1. Tighten V-belts.
	2. V-belts worn out.	2. Replace V-belts.
Loud noise coming from machine.	1. Motor pulley set screws or keys are missing or loose.	1. Replace or tighten if necessary.
	2. Drive belts are damaged.	2. Replace drive belts.
Tables are hard to adjust.	1. Table spindles are tight.	1. Clean and lubricate spindles.
Job stops or slows during cut.	1. Taking too of a deep cut.	1. Take smaller cuts.
	2. Pitch or build-up on planer components.	2. Clean the tables and cutter head components

Chipping or marks (consistent pattern).	1. Knots or conflicting grain direction in wood.	1. Inspect job for knots and grain direction; only use good material.
	2. Nicked or chipped blades.	2. Replace affected blades.
	3. Taking too of a deep cut.	3. Take smaller cuts.
Furry finish on the grain.	1. Wood has high moisture content or surface wetness.	1. Check moisture content and allow to dry.
	2. Blunt blades.	2. Replace the blades.
Lines or ridges that run along the board.	1. Nicked or chipped blades.	1. Replace blades.
Chatter marks across the face of the board. Uneven blade marks.	1. Worn cutter head bearings.	1. Replace cutter head bearings.
Shiny finish.	1. Blades are blunt.	1. Replace the blades.
	2. Too fine a cut.	2. Increase the depth of cut.
Chip marks, random pattern.	1. Chips not removed from cutter head.	1. Use a dust collection system or a stronger dust collection system
Snipe.	1. Dull blades.	1. Replace blades.
	2. Inadequate support for long board.	2. Use support stand.
Torn grain.	1. Cut too deep.	1. Reduce cut.
	2. Cutting against the grain.	2. Cut with the grain.
	3. Dull blades.	3. Replace the blades.
Poor feeding of job.	1. Feed rollers worn.	4. Replace feed rollers.
	2. Motor belt slippage.	2. Re-tension drive belts.
	3. Table dirty.	3. Clean table.
Tapered cut.	1. Table not parallel to cutter head.	1. Reset table to cutter head.
	2. Blades not adjusted correctly.	2. Reset blades.

Exploded view drawings

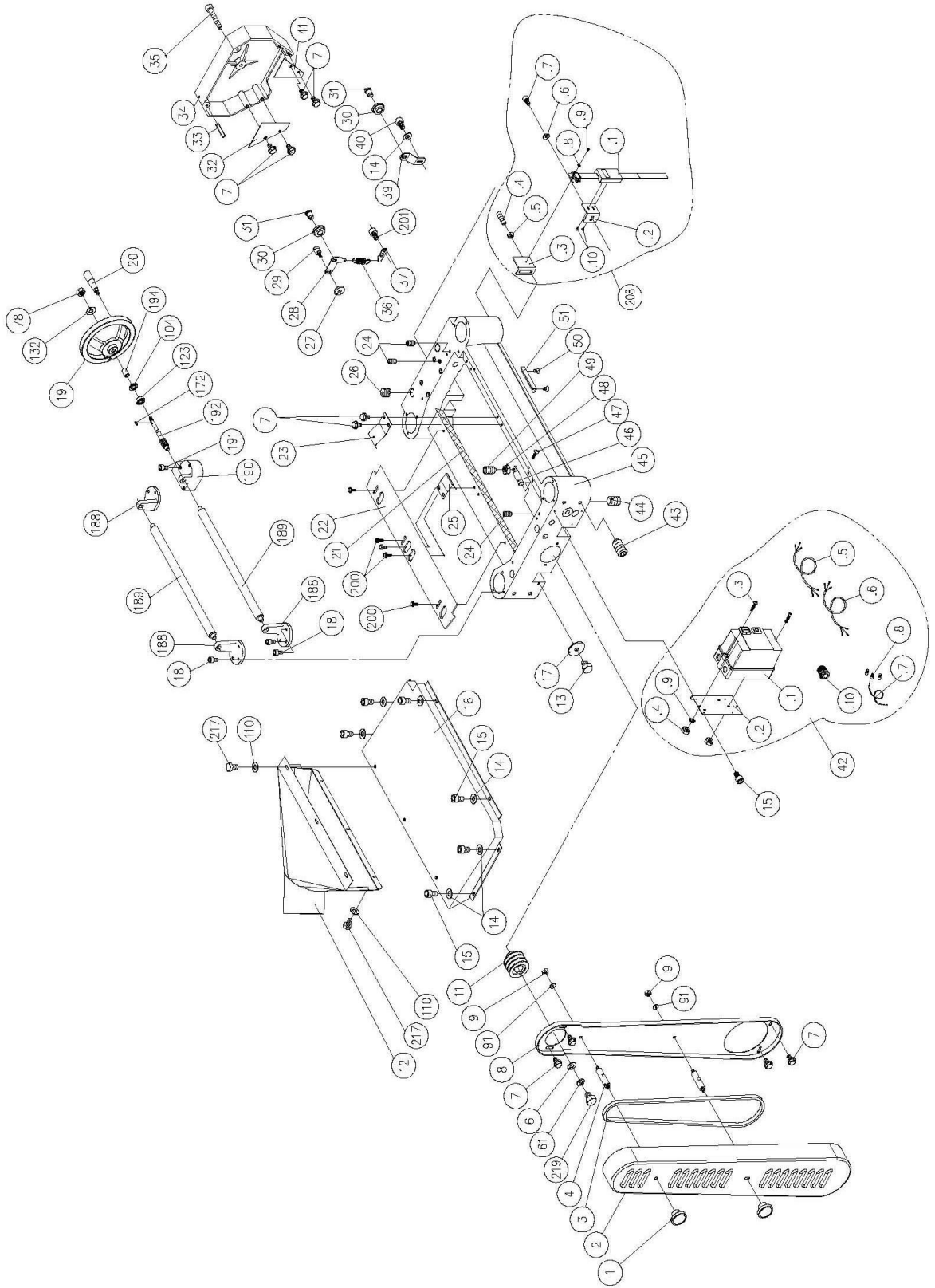

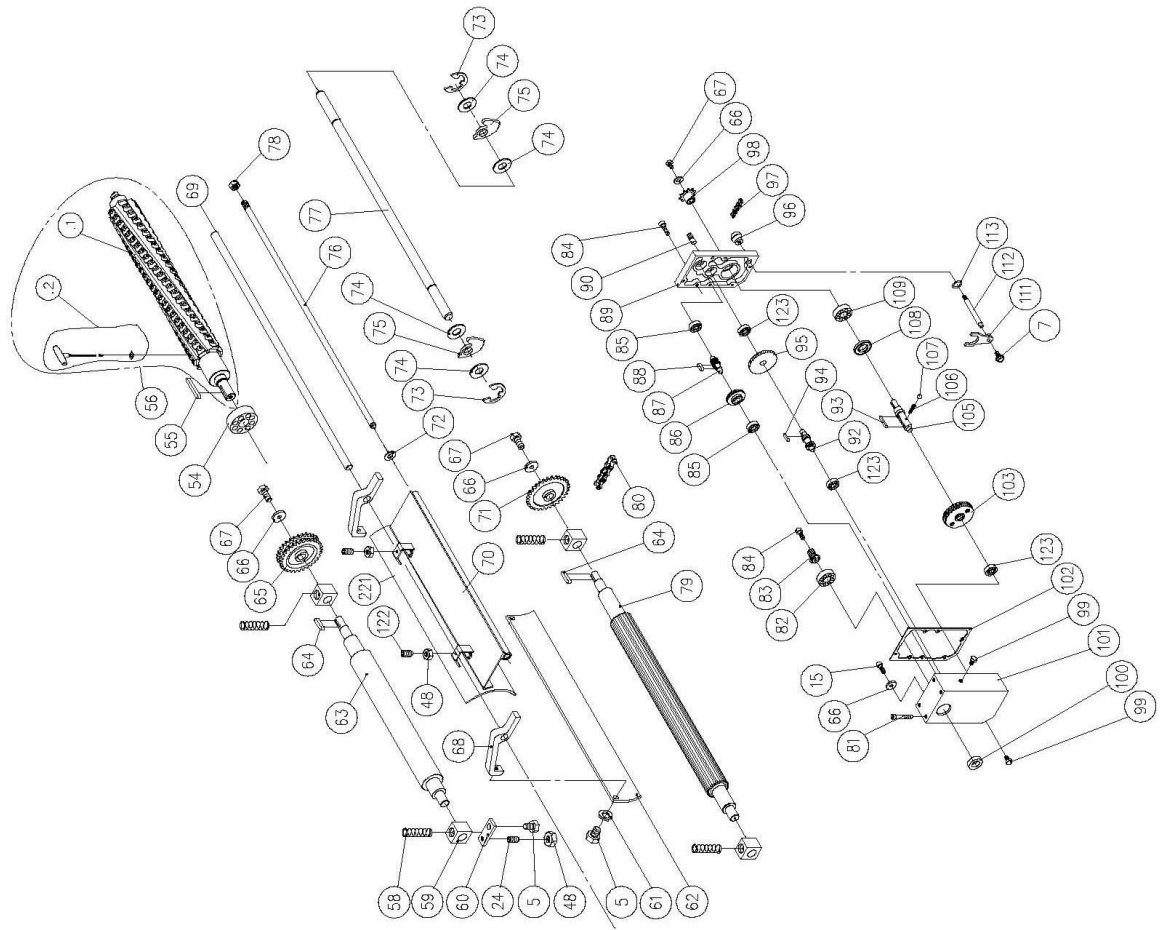

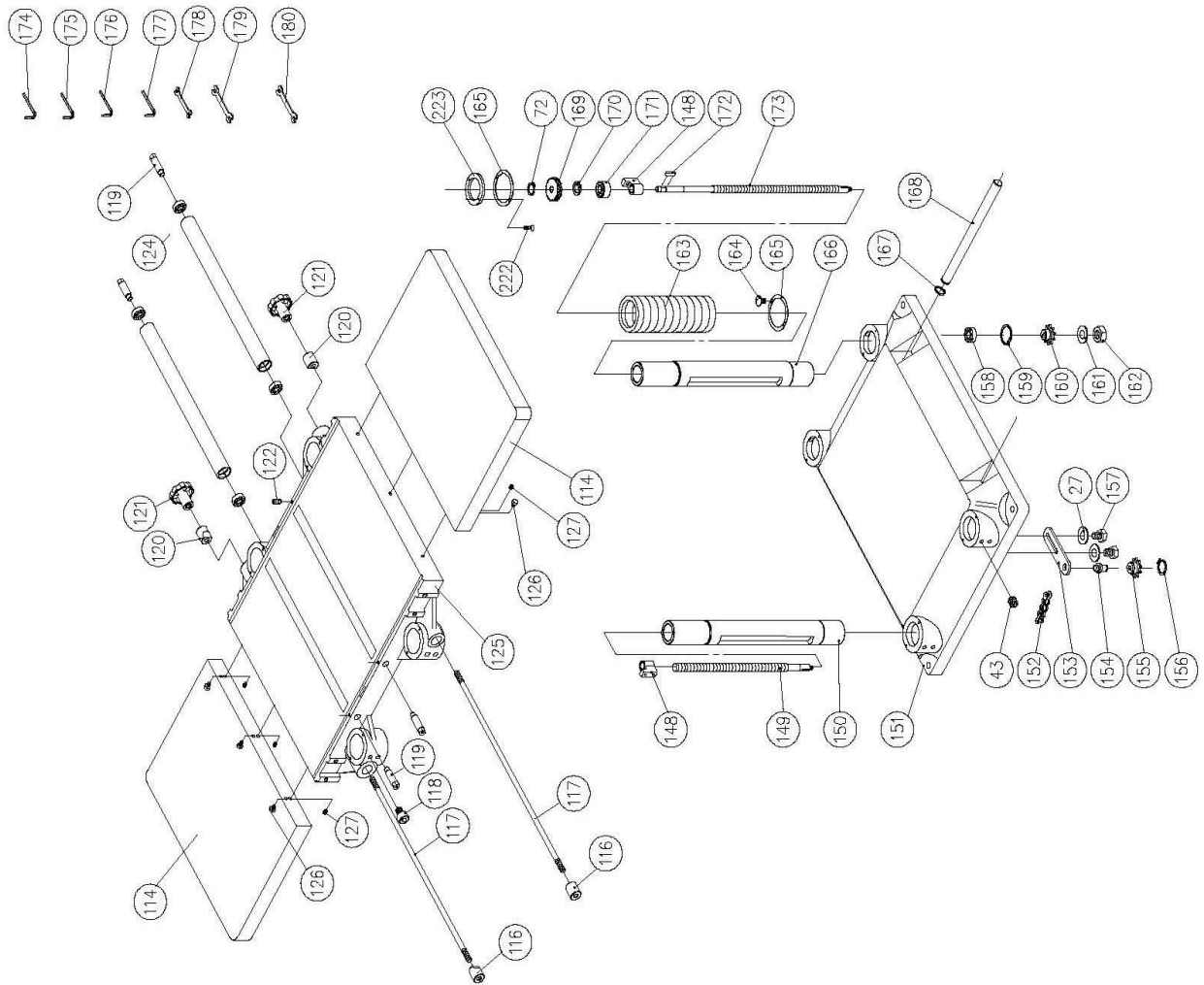

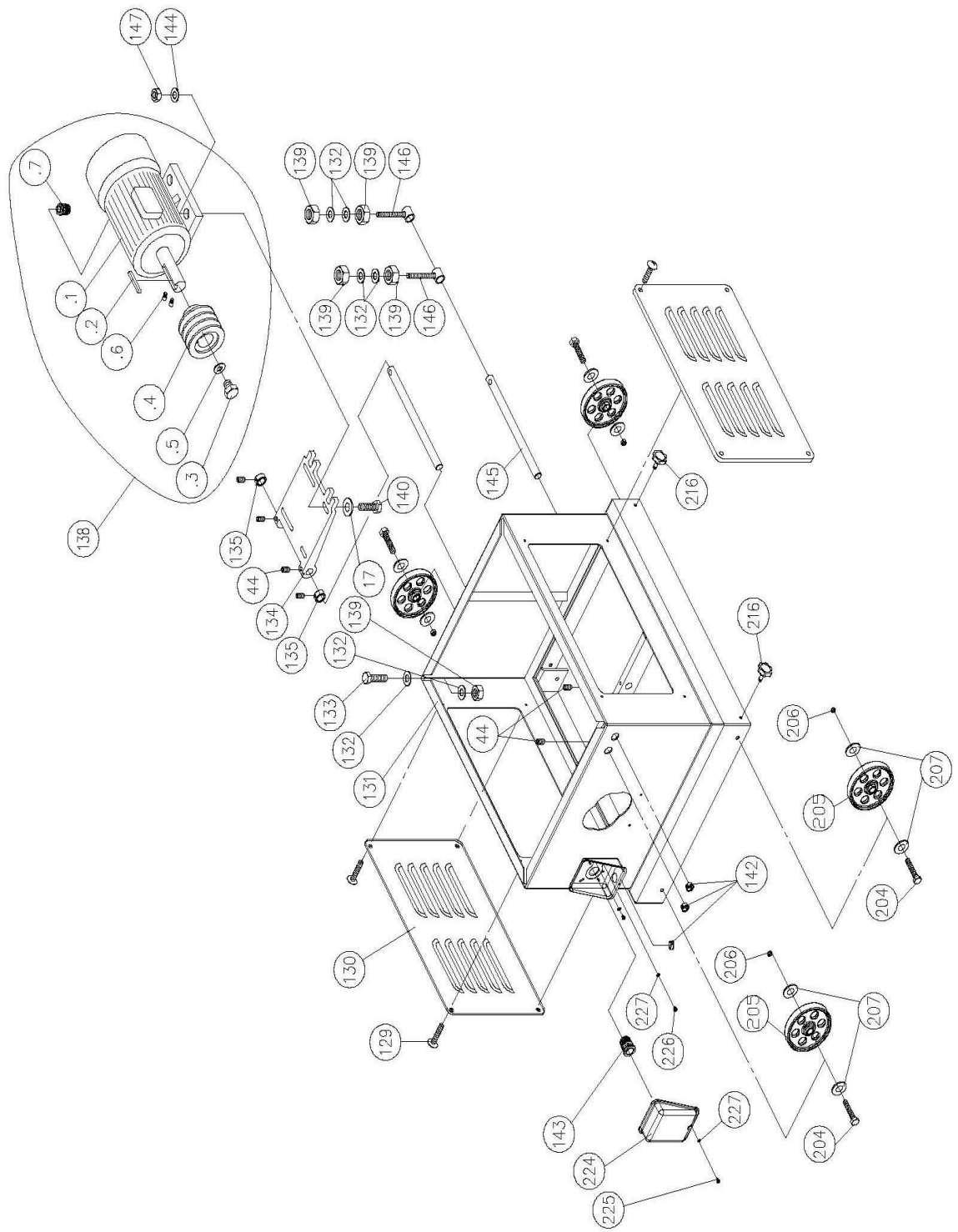

PARTS LIST FOR MPLAN2010-0130

Key	Part No.	Descriptions		Q'ty
1	230118-000	NUT		2
2	170871-000	BELT GUARD FRONT		1
3	014009-000	V-BELT	M57	3
4	380147-901	BOLT		2
5	000003-204	HEX. SCREW	M8*1.25P*20	7
6	006001-043	FLAT WASHER	8.2 *30*4.0t	2
7	000902-202	HEX SCREW W/WASHER	M6*1.0P*12	15
8	170432-000	BELT GUARD REAR		1
9	009005-200	HEX NUT	5/16"-18NC	2
11	050273-901	CUTTERHEAD PULLEY		1
12	170488-000	DUST CHUTE		1
13	000002-201	HEX. SCREW	M6*1.0P*12	4
14	006002-032	FLAT WASHER	6.6*13*1.0t	8
15	000103-103	SOC HD CAP SCREW	M6*1.0P*12	9
16	170494-000	DUST HOOD		1
17	006001-056	FLAT WASHER	8.5*23*2.0t	8
18	000103-106	SOC HD CAP SCREW	M6*1.0P*16	9
19	240017-000	HAND WHEEL		1
20	230114-906	HANDLE		1
21	200021-000	SPONGE		1
22	250172-617	CHIP DEFLECTOR		1
23	270015-901	SPRING PLATE		3
24	000203-106	SET SCREW	M6*1.0P*16	7
25	270017-901	SPRING PLATE		1
26	380200-901	SCREW		4
27	006001-041	FLAT WASHER	8.2*22*3.0t	3
28	170405-901	BRACKET		1
29	290039-901	SHAFT		1
30	130071-000	CHAIN TENSIONER		2
31	360349-902	CHAIN TENSIONER SHAFT		2
32	170473-904	SIDE COVER GUARD		1
33	011004-102	SPRING PIN	6*20	2

34	050292-000	SIDE COVER		1
35	000104-112	SOC HD CAP SCREW	M8*1.25P*40	1
36	280050-000	SPRING		1
Key	Part No.	Descriptions		Q'ty
37	170406-901	HOOK		1
39	170474-901	SHAFT		1
40	000103-110	SOC HD CAP SCREW	M6*1.0P*35	1
41	170475-904	SIDE COVER GUARD		1
42	937574-000	MAGNETIC SWITCH ASSY	5HP.1PH	1
42.1	821007-030	MAGNETIC SWITCH	5HP.1PH	1
42.2	172507-904	SWITCH MOUNTING PLATE		1
42.3	003303-207	ROUND HD SCREW	3/16"-24NC*5/8"	2
42.4	009003-200	HEX NUT	3/16"-24NC	2
42.5	473004-037	MOTOR CORD	SJT12AWG*3C*1450mm	1
42.6	473004-036	POWER CORD	SJT12AWG*3C*2000mm	1
42.7	471004-012	SWITCH CORD	SJT12AWG*1C*150mm	1
42.8	021203-000	RELIEF BUSHING	SW-P6H	3
42.9	006502-100	TOOTH WASHER	5.3*10	2
42.10	021385-000	RELIEF BUSHING	PGA13.5-11B	2
43	000205-101	SET SCREW	M10*1.5P*12	16
44	000204-103	SET SCREW	M8*1.25P*12	7
45	050293-000	HEAD CASTING		1
46	360385-901	SHAFT		2
47	002301-201	Round Head Rivet	2*5	4
48	008005-200	HEX NUT	M6*1.0P	8
49	000203-107	SET SCREW	M6*1.0P*20	2
50	000402-202	FLAT HEAD SCREW	M5*0.8P*8	2
51	170409-901	LIMIT PLATE		1
54	033705-000	BALL BEARING	6206-2NKE	1
55	012204-001	KEY	8*8*36	1
56	922850-000	SHEARTEC 2 CUTTERHEAD ASSY		1
56.1	922851-000	SHEARTEC 2 CUTTERHEAD		1
56.2	850586-000	HARDWARE BAG		1
	040703-000	TORX SCREW DRIVER	T-25	2
	038201-702	TORX SCREW	#10-32UNF*12.5	10

	210114-000	KNIFE	15*15*2.5t	10
58	280051-000	SPRING		4
59	130039-000	BUSHING		4
60	170408-902	RETAINER PLATE		4
61	006305-100	SPRING WASHER	8.2*15.4	3
62	170477-019	PRESSURE PLATE		1
Key	Part No.	Descriptions		Q'ty
63	360405-000	OUTFEED ROLLER		1
64	012003-008	KEY	5*5*22	2
65	070012-000	CHAIN SPROCKET		1
66	006001-020	FLAT WASHER	6.2*20*3.0t	4
67	000002-203	HEX. SCREW	M6*1.0P*16	3
68	070016-025	BRACKET		2
69	360386-000	SHAFT		1
70	170478-019	CHIP BREAKER		1
71	070013-000	CHAIN SPROCKET		1
72	010003-000	RETAINING RING	STW-12	2
73	010209-000	RETAINING RING	ETW-15	2
74	250160-615	SPACER		56
75	172281-905	ANTI-KICK BACK		55
76	360387-000	SHAFT		1
77	360388-000	SHAFT		1
78	008009-200	HEX NUT	M12*1.75P(19B*10H)	2
79	360389-000	INFEED ROLLER		1
80	016308-002	CHAIN	#06B*67P	1
81	000104-114	SOC HD CAP SCREW	M8*1.25P*50	4
82	030109-000	BALL BEARING	6204-ZZ	1
83	320196-000	GEAR		1
84	000103-108	SOC HD CAP SCREW	M6*1.0P*25	5
85	030701-000	BALL BEARING	6201	2
86	320197-000	GEAR		1
87	320160-000	SHAFT		1
88	012003-003	KEY	5*5*12	1
89	050280-000	GEARBOX COVER		1
90	360355-901	PIN		2

91	006002-046	FLAT WASHER	8.5*16*1.5t	2
92	320205-000	SHAFT		1
93	012004-003	KEY	6*6*40	1
94	012003-002	KEY	5*5*10	1
95	320198-000	GEAR		1
96	250372-615	KNOB		1
97	016304-000	CHAIN	#06B*50P	1
98	150008-000	CHAIN SPROCKET		1
99	043401-000	PLUG	PT1/4"-19牙	2
Key	Part No.	Descriptions		Q'ty
100	043608-000	OIL SEAL	TC28*40*8	1
101	050281-000	GEARBOX		1
102	340012-615	GEARBOX GASKET		1
103	922351-000	GEAR ASSEMBLY		1
104	010102-000	RETAINING RING	RTW-32	1
105	360357-901	SHAFT		1
106	280052-000	SPRING		1
107	017002-000	STEEL BALL	6	1
108	043505-000	OIL SEAL	SC25*47*6	1
109	030306-000	BALL BEARING	6204Z(A)	1
110	006001-032	FLAT WASHER	6.6*13*1.0t	7
111	070014-000	SHIFTING CLAW		1
112	360358-901	SHAFT		1
113	043303-000	RETAINING RING	P12	1
114	050301-000	EXTENSION TABLE		2
116	130038-000	COLUMN LOCK BUSHING		2
117	360390-000	SHAFT		2
118	000104-104	SOC HD CAP SCREW	M8*1.25P*16	8
119	360391-000	ECCENTRIC SHAFT		4
120	130037-000	COLUMN LOCK BUSHING		2
121	230115-000	KNOB		2
122	000203-104	SET SCREW	M6*1.0P*12	6
123	030304-000	BALL BEARING	6201Z	4
124	921208-000	ROLLER W/BEARING		2
125	050302-000	TABLE		1

126	000003-105	HEX. SCREW	M8*1.25P*25	6
127	000204-105	SET SCREW	M8*1.25P*20	6
129	000403-204	FLAT HEAD SCREW	M6*1.0P*20	8
130	170479-000	STAND ACCESS PANEL		2
131	922874-000	STAND		1
132	006002-091	FLAT WASHER	13*28*3.0t	13
133	000005-202	HEX. SCREW	M12*1.75P*50	4
134	050321-008	MOTOR PLATE		1
135	190074-901	SPACER		2
138	900755-000	MOTOR ASSY	5HP*230V*60HZ*1PH	1
138.1	593012-000	MOTOR	5HP*230V*60HZ*1PH	1
138.2	012202-002	KEY	5*5*30	1
Key	Part No.	Descriptions		Q'ty
138.3	000003-204	HEX. SCREW	M8*1.25P*20	1
138.4	050351-902	MOTOR PULLEY		1
138.5	006001-043	FLAT WASHER	8.2*30*4.0t	1
138.6	021203-000	RELIEF BUSHING	SW-P6H	2
138.7	021369-000	RELIEF BUSHING	PGA13.5-11B	1
139	008009-100	HEX NUT	M12*1.75P	8
140	000003-208	HEX. SCREW	M8*1.25P*40	4
142	021801-000	RELIEF BUSHING	NB-1722	3
143	021369-000	RELIEF BUSHING	PGA13.5-11B	1
144	006001-046	FLAT WASHER	8.5*16*1.5t	4
145	360394-000	MOTOR MOUNTING SHAFT		2
146	380249-901	MOTOR MOUNT TENSION SHAFT ASSEMBLY		2
147	008006-200	HEX NUT	M8*1.25P	4
148	130045-000	NUT		4
149	360395-000	COLUMN SHAFT		3
150	050296-000	COLUMN		3
151	050297-000	BASE CASTING		1
152	016004-000	CHAIN	#40*166P	1
153	170413-901	CHAIN TENSIONER BRACKET		1
154	360362-902	SPROCKET SHAFT		1
155	150011-000	CHAIN SPROCKET		1

156	010006-000	RETAINING RING	STW-15	1
157	000003-205	HEX. SCREW	M8*1.25P*25	2
158	030305-000	BALL BEARING	6202Z(A)	4
159	010103-000	RETAINING RING	RTW-35	4
160	150012-000	CHAIN SPROCKET		4
161	006001-078	FLAT WASHER	10.5*19*1.5t	4
162	008008-100	HEX NUT	M10*1.25P	4
163	250173-000	EXPANSION BEND		8
164	001104-502	ROUND HEAD TAPPING SCREW	M5*2.12P*10	30
165	170481-901	FIXING BUSH		16
166	050298-000	MAIN COLUMN		1
167	010202-000	RETAINING RING	ETW-17	4
168	360396-902	ROD		4
169	320203-000	WORM GEAR		1
170	010104-000	RETAINING RING	RTW-38	1
171	130046-000	BUSHING		1
Key	Part No.	Descriptions		Q'ty
172	012002-004	KEY	4*4*10	2
173	360397-000	ELEVATING SCREW		1
174	040003-000	HEX. WRENCH	3mm	1
175	040004-000	HEX. WRENCH	4mm	1
176	040005-000	HEX. WRENCH	5mm	1
177	040006-000	HEX. WRENCH	6mm	1
178	040201-000	WRENCH BOX	8*10	1
179	040204-000	WRENCH BOX	12*14	1
180	040206-000	WRENCH BOX	17*19	1
188	050299-000	ROLLER BRACKET		3
189	360398-902	ROLLER		2
190	050300-000	ELEVATING SCREW GEARBOX		1
191	000103-113	SOC HD CAP SCREW	M6*1.0P*50	3
192	320204-000	SHAFT		1
194	190008-901	SPACER		1
200	000902-203	HEX SCREW W/WASHER	M6*1.0P*16	5
201	000103-102	SOC HD CAP SCREW	M6*1.0P*10	2
204	003005-206	HEX. SCREW	3/8"-16NC*2-1/2"	4

205	250402-000	WHEEL		4
206	009102-200	HEX NUT	3/8"-16NC	4
207	006002-077	FLAT WASHER	10.5*19*1.0t	8
208	921246-000	DIGITAL READ OUT	9 inch	1
208.1	921245-000	DIGITAL READ OUT	9 inch	1
208.2	171370-904	BRACKET		1
208.3	171371-904	BRACKET		1
208.4	000205-102	SET SCREW	M10*1.5P*30	1
208.5	008007-100	HEX NUT	M10*1.5P	1
208.6	006001-045	FLAT WASHER	8.5*16*1.0t	1
208.7	000104-110	SOC HD CAP SCREW	M8*1.25P*30	1
208.8	006001-001	FLAT WASHER	4.3*10*1.0t	1
208.9	000302-101	ROUND HD SCREW	M4*0.7P*6	1
208.10	000301-101	ROUND HD SCREW	M3*0.5P*6	2
216	004001-101	KNOB	5/16"-18NC*3/4"	2
217	000002-201	HEX. SCREW	M6*1.0P*12	6
219	048201-204	HEX HEAD SCREW	M8*1.25P*30	1
220	003905-201	WOOD SCREW	1/4"-20NC-1"	16
221	200057-646	SPONGE	3/8"*1/2"*525L	1
Key	Part No.	Descriptions		Q'ty
222	000303-105	ROUND HD SCREW	M5*0.8P*15	2
223	380168-901	WASHER		1
224	490124-000	TERMNAL COVER		1
225	003303-102	ROUND HD SCREW	3/16"-24NC*1/4"	1
226	000303-103	ROUND HD SCREW	M5*0.8P*10	2
227	006502-100	TOOTH WASHER	5.3*10	3

LAGUNA

2072 Alton Parkway. Irvine, CA 92606
Ph: 800.234.1976 | www.lagunatools.com

Laguna Tools is not responsible for errors or omissions.
Specifications subject to change. Machines may be shown with optional accessories.

© 2018, Laguna Tools, Inc. LAGUNA® and the LAGUNA Logo® are the
registered trademarks of Laguna Tools, Inc. All rights reserved.